

# elektor

up-to-date electronics for lab and leisure

D 71683

90

October 1982

75p.

(R 114 p. (incl. VAT)

\$ 2.50

**LCD thermometer**  
**short wave band shifting**  
**ultrasonic yardstick**  
**active antenna**  
**electrolytics run dry**

*Swiss Inf*  
*15/82*



<b>selektor</b> .....	10-14
<b>DSB demodulator</b> .....	10-17
After our crash course in transmission and reception, we introduce another type of modulation: DSSC or more commonly known as DSB.	
<b>L.C.D. thermometer</b> .....	10-20
We present a digital circuit, which is inexpensive, accurate, precise, and has a very low power consumption. The range of the instrument is such that it is suitable for practically any application.	
<b>ultra sonic distance measurement</b> .....	10-24
An electronic method for the measurement of distances, using ultra-sonic sound. A very good starting point for experimentation.	
<b>electrolytics run dry</b> .....	10-28
The article describes and discusses the merits of the different kinds of electrolytics, arriving at a surprising conclusion.	
<b>darkroom computer - part 2</b> .....	10-30
A continuation of the first part in the last issue. This article deals with the accessories needed to make the computer fully operational.	
<b>short wave band shifting for SSB receivers</b> .....	10-36
The article deals with and describes front ends which can be used with any short wave receiver, effectively extending the coverage of the amateur bands.	
<b>16 channels with only five ICs</b> .....	10-40
A straightforward easily constructed infra-red remote control. Construction is made easy by using special ICs produced for the purpose.	
<b>pre-amp for the SSB receiver</b> .....	10-44
An additional MOSFET pre-amp not only increasing the sensitivity, and improving selectivity, but also extending the AGC range.	
<b>active aerial</b> .....	10-46
An active aerial which is short and convenient to use, whilst enabling good reception. What more would DXers wish.	
<b>transistor and IC data</b> .....	10-49
comprehensive information on a selection of CMOS ICs and transistors. very useful aid.	
<b>missing links</b> .....	10-54
<b>market</b> .....	10-54

# contents

## CONTENTS

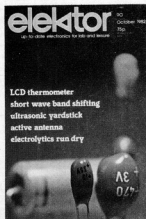

*Surender Singh*  
13/9



# selektor 2019101

## Power from the invisible universe

*A theory linking black holes, quasars and radio jets in galaxies may explain the basis of the universe and point to its eventual end in a so-called Big Crunch.*

Only a few years ago it seemed that astronomers were drawing near to a comprehensive understanding of the universe. Mysterious objects remained, notably the quasars with their extraordinary brightness, but a pattern was emerging that promised to encompass all the categories of stars and galaxies that astronomers could see.

To some extent that is still true today. But what is becoming apparent is that the universe we can observe with any kind of radiation, including radio waves, infra-red, ultra-violet and X-rays, is probably only a small fraction of the entire universe. Most of it is invisible because the matter it comprises produces no radiation for astronomers to detect with their telescopes.

But this unseen matter cannot be ignored. Although it is invisible, it is probably responsible for the most violent events in the visible universe. And its presence may be the factor deciding the fate of the universe, whether it will go on expanding for all eternity or whether it will instead stop expanding, contract and finally disappear in a Big Crunch, the precise opposite of the Big Bang in which it came into being.

## Quasars and Black Holes

The two most mysterious objects in the known universe are quasars and black holes. Quasars are strange super-stars, each one shining more brightly than thousands of complete galaxies of stars, yet producing its radiation from something with a diameter no greater than that of the solar system. Because quasars shine so brightly they are visible at distances of several thousand million light years. This means that we are seeing them not as they are now but as they were several thousand million years ago, when the universe (which began at some time between ten and fifteen thousand million years ago) was relatively young. This has suggested to astronomers that, because no quasars to be nearer at hand, in more recent epochs, whatever provides the power for them may be some force which is now spent.

Black holes the fates of large stars when their nuclear fuel finally burns out.

When this happens there is no longer outward explosive force to balance the inward gravitational forces caused by every particle of matter in the star attracting every other particle of matter, so the star collapses inwards and becomes more and more dense. It passes through the stage where the electrons orbiting atoms are squashed inwards to fuse with protons, the negative and positive charges cancelling each other, thereby forming neutrons. Smaller stars stop contracting at this stage and form so-called neutron stars made of collapsed atoms. They are dotted around the universe and can be detected by their gravitational effects on other stars. But in larger stars the inward gravitational forces are so strong that theory predicts they will go on collapsing inwards until all the matter in such a star has been compressed into a dimensionless point. A star which has reached that stage can no longer be observed because no radiation can leave it. For this reason, and because events inside it can no longer be understood through conventional physics, it is called a black hole.

## Radio Jets

Black holes are no longer just theoretical notions. X-ray telescopes have detected radiation coming from two or three objects which are very probably other stars in orbit around black holes. More recently, there has been growing suspicion that violent events in the centres of galaxies may be caused by black holes being formed there. In the

UK, Professor Martin Rees of the Cambridge Institute of Astronomy and his colleagues have put forward a theory which not only explains quasars in terms of black holes but explains another mysterious phenomenon, too, so-called jets in radio galaxies.

Radio galaxies, the main class of objects detected by radio telescopes, appear usually to contain an ordinary optical galaxy with a characteristic disc shape. Protruding from the centre of the disc in each direction perpendicular to it, giving the appearance of a wheel on an axle or of a spinning top, are jets of radiation and charged particles shooting such colossal distances into space that they dwarf the galaxy from which they come.

To understand Professor Rees's theory, it is necessary to go back in time at least nine tenths of the way to the origin of the universe, to a period about one thousand million years after the Big Bang. At that time, swirling clouds of gas were separating from each other and forming spinning, protogalactic discs with solid stars condensing out of the gas. As the stars formed, the remaining gas sank towards the centre of each galaxy, attracted by the pull of the denser matter. There were no forces, other than those which mutually repel neighbouring atomic particles, to slow down the inward collapse of the gas into each galactic centre. So collapse soon proceeded to the point where a black hole formed. More and more matter was pulled into the black hole by its enormously powerful gravitational field, so its pull grew still

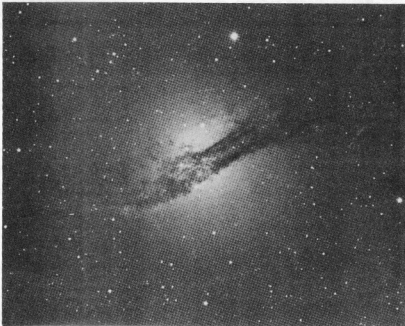

Photograph of Centaurus A taken at the Anglo-Australian telescope on Siding Spring Mountain in Australia. Centaurus A is the nearest of the great radio galaxies and is believed to have an enormous black hole at its centre.

# selektor 26 ELEKTOR

stronger until it drew neighbouring stars into itself, as well as dust and gas.

## Synchrotron Radiation

This, says Professor Rees, is the stage of galactic evolution represented by the quasars. They are young galaxies in which the central black holes are still sucking in stars. While the stars are being pulled into the black hole, before they disappear for ever, they are accelerated to velocities near to the speed of light. Matter accelerated to such speeds gives off powerful radiation, called synchrotron radiation (see Spectrum 129). The extraordinarily powerful synchrotron radiation we observe from quasars is on the scale to be expected from a black hole scouring the centre of a galaxy cleaned of millions of stars. When there are no more stars left near enough to be swallowed, the quasars revert to the radiative power of ordinary galaxies. There are no quasars today because there is no matter left in the centres of galaxies to be swallowed by the black holes that lurk there. No other phenomenon is powerful enough to produce the quasar radiation. But, says Rees, that is not the end of the story. Because the galaxies in which they are formed rotate, the black holes in their centres rotate, too. And because they are made of infinitely dense matter the black holes rotate virtually as fast as it is possible to rotate. They spin at near to the speed of light. Surrounding the centre of each galaxy is a magnetic field which is formed, predictably, in gas that is too far away from the black hole to have been sucked into it. The magnetic field in the centre of such a galaxy pulls on the spinning black hole, acting as a persistent brake upon it. When a brake is applied to any moving object energy is lost; one example is the heat given off when wheels are braked. When a brake is applied to a mass of a hundred million or so stars in a black hole spinning at a speed of near to 186 000 miles/second, we may expect the energy produced to be on an unfamiliar scale.

This energy, Rees proposes, is the explanation of the jets in the radio galaxies. The magnetic fields that surround the spinning black holes have narrow tunnels running through them to each side, perpendicular to the galactic plane, and the colossal energy produced from the braking effect of the magnetic field on the black hole is flung out through the tunnels. It emerges, shooting out through space,

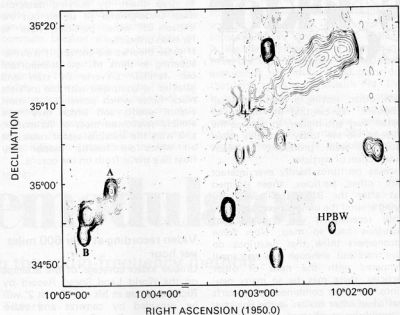

The double radio source 3C236. Contour lines map the intensity of the radio emission showing the source to have 'radio lobes' (at the bottom left and top right of the map) separated by 20 million light-years.

as jets of particles and radiation dwarfing the galaxy they come from.

Professor Rees believes that the evolution of galaxies into the quasar stage and onwards, with the formation of spinning black holes and radio jets, is probably a very common, perhaps almost universal process. Most galaxies, including our own, have gone through it. Spinning black holes may form from single stars as well as from millions of stars in the centres of galaxies. Single-star black holes would produce miniature radio jets. Two objects with structures that resemble or suggest the existence of such jets are known, namely the bright X-ray star Scorpio XI and the optically visible source SS433.

## Violent Events

So this theory explains and links the three strangest phenomena in the known universe, black holes, quasars and radio jets. But it implies that we must look for the explanation of the most violent events in the visible universe in matter which can no longer be observed in that universe, in black holes. And if we are to predict the fate of the universe, say Rees and certain other astronomers, we must again take into account black holes and other categories of invisible matter.

It is possible for astronomers to calculate how much matter there would need to be in the universe for the gravitational forces pulling it together eventually to overcome the outward forces of expansion, so that the universe will eventually stop expanding and

start to contract towards a Big Crunch. For this to happen, the universe in its present stage of expansion needs to contain an average of about three atoms rules out the crunch, because all the matter in the universe that has been observed by any kind of telescope adds up to only about one-tenth of one atom per cubic metre. But, says Rees, there is a lot of matter in the universe that we have not seen and can never see. And there is growing evidence that this invisible matter greatly outweighs the visible.

Some galaxies orbit around one another in pairs, like double stars. Their masses, calculated from their orbits, are estimated to be at least ten times that of their visible matter. This is still only one third of the mass needed to ensure a Big Crunch, but it does indicate that only about one-tenth of the matter in galaxies can be detected with any kind of telescope. Some of the rest may already have disappeared for ever into black holes. Perhaps as much as nine-tenths of the matter in the universe has gone that way. More invisible matter may be in the form of 'dark' stars, which have burnt out without collapsing into black holes but which no longer emit enough radiation to make them observable.

The amount of invisible matter which is present in a third form, particles called neutrinos, may dwarf that present in the visible universe.

In the first fraction of a second after the Big Bang, matter and its opposite, antimatter were probably created almost equally. They promptly annihilated

# selektor

each other, leaving a relatively small residuum, representing the margin of matter over anti-matter, to become the universe we see today. Particles called neutrinos were produced by each annihilation of particles.

Because neutrinos hardly ever interact with other particles, those formed just after the Big Bang have been flying around the universe ever since.

Until recently it was thought that neutrinos had no mass. Now some astronomers think that neutrinos do have mass and, although it is very small compared with the mass of other particles, there may be so many neutrinos that their combined mass dwarfs that of all other matter in the universe. It could be much more than enough to ensure a Big Crunch. The problem

is how to detect neutrinos. Attempts to trap them, by burying detectors deep underground to screen out the impacts of other particles, have so far been unfruitful.

If these theories are correct, it is rather sobering to think of how unimportant our familiar universe of stars and galaxies is, compared with the invisible black holes which power all its most violent events and which may have already swallowed most of its matter, and with the invisible sea of neutrinos on which our familiar matter may float like trivial froth on the oceans.

(8135)

## Video recording at over 600 miles per hour

Unique video coverage of the attempt on the World Land Speed Record by Richard Noble in his car 'Thrust 2' will be provided by cameras and video recorders from Sony Broadcast.

A lightweight video colour camera will

be installed in the spare cockpit of the jet-powered car during the attempts to break the world record of 622 mph on the Bonneville Salt Flats in Utah, U.S.A.

Sony equipment is being used by Intervideo Productions Ltd. to record a documentary covering the 7 year development programme of 'Thrust 2', the people involved in the project and all the activities during the attempt in Utah. Three main camera teams will record the activities at base camp, the refuelling point at the end of the runway and from the air in a hot air balloon or a light aircraft. In addition, the camera installed in the car itself will provide dramatic shots of both the car's instrument panel and scenes of the runway as viewed by the driver.

To break the record, 'Thrust 2' has to make two passes over a measured mile, in opposite directions, within an hour. From standing start and acceleration through the measured mile and then deceleration will take something like 45 seconds over a distance of 10 miles. At the point of braking considerable G forces of up to 6.5 G will be experienced by the driver, but it is not yet known how the video camera and recorder will function under these conditions.

The camera's weight factor combined with the vibration from both the movement of the car over the salt flats plus high frequency vibrations from the Rolls Avon 403 jet engine (which produces some 17 tons of thrust) creates a very critical environment for both camera and recorder in terms of microphony.

The weight of any item of equipment is multiplied by the G force applied. This means that the Sony camera, which weighs 10 lbs under normal gravity conditions, will have an actual weight of over 60 lbs on deceleration from 650 mph.

At present the camera is providing vital telemetry information on the behaviour of the car as well as an accurate record of the instrumentation read-out from the spare cockpit.

Richard Noble will be attempting to break the World Land Speed Record later this year at a speed in excess of 650 mph.

Sony Broadcast Limited

(806 S)

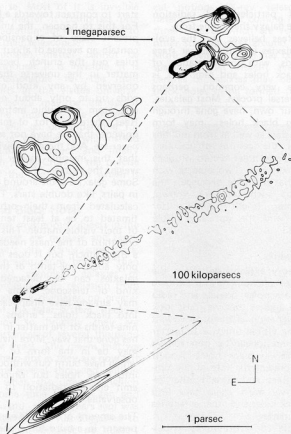

Structure of the radio source around the galaxy NGC 6251, with detail magnified in two stages. The parsec, a unit of stellar distance, is equivalent to 3·26 light-years.

# selektor

Conventional amplitude modulation (AM) with carrier should by now be quite familiar. Short-wave, medium-wave and long-wave listening is very common because all the problems of this type of modulation appear to have been solved by the invention of the detector receiver. Nevertheless, for widely varying reasons, the field of telecommunications has provided the impetus to 'invent' many other analogue and digital modulation methods; these are no doubt all justified but make quite different demands on the receiver.

with respect to frequency stability of the demodulator.

At this stage we would like to present another example of DSB which we encounter daily whilst hardly noticing it. We are referring to the stereo signal from the VHF receiver. Advanced radio enthusiasts will immediately point out that VHF radio operates with FM. This is true, but let us examine the stereo signal. It consists of the frequency band L+R, the pilot tone and two L-R bands around the 38 kHz sub-carrier. The carrier is modulated with

# DSB demodulator

## carrier regeneration using the audio-frequency method

In the June 1982 issue we presented an article entitled "The principles behind an SSB receiver" and we hope that it provided answer to some questions. As a practical complement to the "Crash course in transmission and reception" we then presented a complete SSB short-wave receiver for home construction. With this article we would now like to introduce another type of modulation that was mentioned: DSSC (double sideband, suppressed carrier) or, as it is more commonly known, DSB. An appropriate demodulator in a new circuit technique is provided for those who like to become more involved in DSB in future.

### Theory

Nobody really knows why DSB was not able to establish itself successfully. Some cynics tell us that vested interests in SSB carried more weight at the decisive moment. It is possible that the SSB technique was better developed at that time than the DSB technique. In any case, with respect to efficient use of transmitter power, the DSB technique represents a middle route between AM and SSB modulation (figure 1). If, for example, a sinusoidal carrier of a frequency of 4 MHz is modulated with a sinusoidal 'information signal' of a frequency of 1 kHz, two 'side frequencies' are produced in addition to the carrier frequency (3999 kHz and 4001 kHz). This can be proved mathematically but is beyond the scope of this article.

Figure 1 shows a modulated signal as displayed on a spectrum analyser. A spectrum analyser displays the amplitude or, in this case the power level of a signal, as a function of frequency and not as a function of time, as is the case with an oscilloscope. Assuming that the information signal does not consist of one frequency but of a mixture of frequencies, bands are obtained instead of lines in the spectrum of the modulated signal, one to the left and one to the right of the carrier. Both bands contain precisely the same information. The carrier contains no information but requires the most power, as can be seen in figure 1. If the carrier is then suppressed during transmission and the energy it contains is transferred to the information-carrying sidebands, the result is the two types of modulation DSB (DSSC) and SSB. The advantages and disadvantages of SSB were already discussed in the June 1982 issue. With DSB the effective, information-carrying power is doubled with respect to conventional AM. As with SSB, however, the carrier must be regenerated at the receive end. This is quite a challenge

the L-R signal in DSB technique. Thus the carrier is initially missing in the receiver. The entire signal is finally frequency-modulated with the RF carrier. To avoid any misunderstandings, we are not designing a new type of stereo decoder here, but merely wanted to provide an example of DSB!

### Block diagram

Figure 2 shows the block diagram of a DSB superhet receiver. The input signal is mixed with an oscillator signal. The output of this oscillator is somewhat higher in frequency than the input signal and is tuned simultaneously with the input signal. In this way the frequency difference between input signal and oscillator signal remains constant over the entire tuning range of the receiver (455 kHz in this example). The 'difference signal' is known as the IF (intermediate frequency).

The output signal of the IF amplifier is applied to the input of the DSB demodulator. Mixing then takes place here too, but this time with a square-wave signal from the sampler. The result is an audio-frequency signal from which the carrier (now an AF carrier) is regenerated with relatively simple means. If this carrier is then mixed with the IF signal previously obtained by subtractive mixing, the AF signal is presented at the output. The frequencies given in figure 2 relate to the example in figure 1.

The term 'sampler' that appears twice instead of oscillator is not really relevant in our case. We are more concerned with carrier regeneration than with the details of AM reception.

The mathematics of the method are complex and involve many trigonometric formulae. The result is straight-forward, however: if two sinusoidal signals, like the 'side frequencies' that we have already met, are multiplied, the carrier is produced with twice the frequency

together with some other frequencies which are filtered out.

### Practice

In contrast, the method is clearer in practice. Multiplication of two sinusoidal signals is normally performed using a 4-quadrant multiplier (ring modulator). We will use a simpler method, however. Since a perfectly sinusoidal signal is not needed at the output, digital multiplication can also be employed. This merely requires an exclusive-OR gate; the original signal and the out-of-phase signal are applied to its inputs. With a phase shift of  $90^\circ$  a square-wave signal appears at its output with twice the frequency of the input signals. This type of phase-comparator, exclusive-OR gate can therefore also be described as a digital 4-quadrant multiplier.

Figure 3 shows the circuit of the DSB demodulator which we shall now exam-

ine step-by-step. T2 performs the function of the second mixer in the block diagram. The corresponding sampler consists of the oscillator with F11 and T3 and switch T4. All types of filter which can be tuned to 455 kHz can be used.

Although the first stage of the demodulator still operates at high frequency, it is followed by audio-frequency stages. The IF signal obtained by subtractive mixing is applied to a potent amplifier via buffer A1. The signal is then amplified until a 'clean' square-wave signal is present at the output of comparator A3. The phase-shift mentioned is performed by integrator A4. It is configured so that this phase-shift takes place between approximately 10 and 30 kHz. The 'shifted' signal is shaped into a square-wave signal by comparator A5. Exclusive-OR gate N1 forms the digital 4-quadrant multiplier. Ignoring for a moment the PLL circuit IC5, the fre-

quency of the output signal of N1 is then divided down by FF1 to the frequency of the carrier. The low-pass filter consisting of R20/P3 and C19 compensates for the  $90^\circ$  phase-shift caused by the PLL circuit ( $45^\circ$  at  $f_{VCC}/2$ ). Comparator A6 forms a square-wave signal from the audio-frequency carrier.

The third mixer mainly consists of T5. Two signals are applied to it: the audio-frequency IF signal via low-pass network R12/C10 and the signal from the sampler consisting of FF2 and N2...N3. This circuit may appear a little strange at first sight, but it is really not complicated. It consists of a monostable that is triggered by the audio-frequency carrier. If a positive pulse appears at pin 11 of FF2, output Q becomes a logic 1. After passing through the delay circuit of N2...N4 a pulse appears at differentiating networks C20/R21, but the flip-flop is simultaneously reset and waits for the next triggering

1

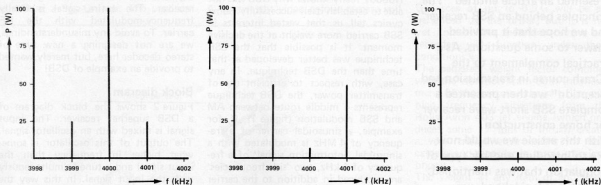

81154-1

Figure 1. Frequency spectrum of a 4 MHz carrier modulated with a 1 kHz signal in AM (1a), DSB (1b) and SSB (1c). All signals are sinusoidal.

2

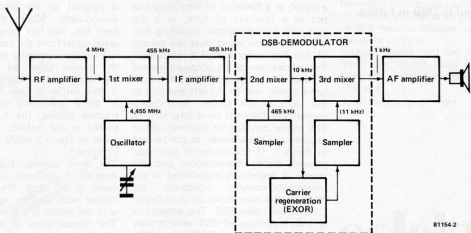

81154-2

Figure 2. Block diagram of a DSB receiver. The demodulator chiefly consists of two mixers and a circuit for carrier regeneration with triggers the sampler of the second mixer.

3

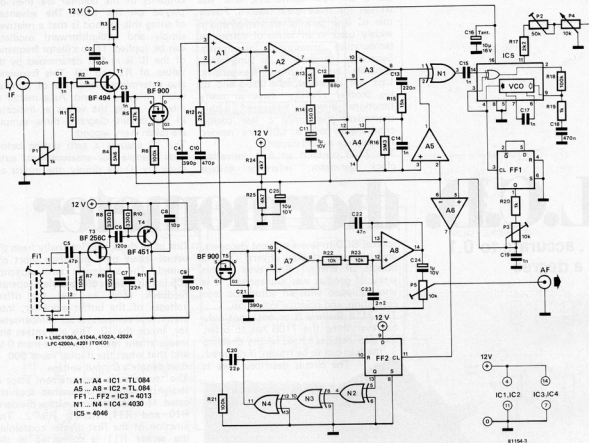

Figure 3. The circuit of the DSB modulator mainly operates in the AF range. For this reason, operational amplifiers and CMOS-ICs are utilized for carrier regeneration and the second mixer. The PLL IC operates as a frequency stabilizer and carrier-buffer.

pulse. During this period T5 conducts; the weighted signal is fed to the active low-pass circuit of A8 via buffer A7 and the audio-frequency signal is present at the output (wiper of P5).

The PLL circuit of IC5 performs two functions. Firstly, of course, it allows a frequency to be 'locked on' very precisely. Secondly, this frequency is also retained when the control voltage for the VCO has become very low. In our case this signifies the following: when viewed on an oscilloscope the DSB signal looks like beads on a string. One would expect the carrier to be at the points of contact between the beads, but there are none. Since the amplitudes of the signals from the mixture of frequencies of the sidebands are very low in this range, the demodulator does not really 'know' whether a useful signal is present. In could simply be noise. Thus, in a manner of speaking, the PLL circuit buffers the generated carrier under conditions of fading field strength, so that the carrier does not disappear again.

#### Application and alignment

The DSB demodulator can be utilised in any AM superhet receiver. Since the

second mixer is a 'harmonic' type, an IF signal in the range of 455 kHz to approximately 20 MHz can be processed. Figure 2 shows the general configuration. The only stage still required at the output of the demodulator is an AF amplifier. Clearly the demodulator also provides advantages in conventional AM reception.

Alignment does not involve any problems, because the audible method is used. First connect the AF amplifier to the output of A1. Tune the receiver to a conventional AM transmission (with carrier) so that a signal is present at the output of the IF amplifier. Adjust the core of F1 so that the whistle in the loudspeaker is just at the audible frequency limit (about 15 kHz). If this tone sounds distorted, the mixer is being overdriven. In that case P1 should be adjusted so that the whistle is barely undistorted.

In the second alignment step, connect the AF amplifier to its real location in the circuit, i.e. to the wiper of P5. Set P2 ... P5 to their middle positions. Then adjust P4 so that the PLL circuit 'locks on'. When a transmission is received, i.e. when modulation is present, (the whistle should cease when the circuit locks on). It may be

necessary to shift the range by adjusting P2.

In the third alignment step, adjust P3 so that the AF signal reaches its maximum. This is precisely the case when the carrier is subjected to a phase-shift of 45° by low-pass network P3/C19. Finally, the output level can be matched to the following amplification stage by adjusting P5. The entire alignment process should be repeated several times. In particular, the distortion caused by selective fading should cease. Instead a kind of phasing effect appears.

One thing becomes clear from the description of the alignment process: if the demodulator does not precisely 'lock on' to the transmission, an unpleasant howling and whistling is heard from the loudspeaker. For this reason, one should tune twice: first in the normal manner with the existing detector and then precisely with the demodulator described here. The only additional controls required on the receiver are a changeover switch and a potentiometer. We hope that this circuit will contribute to an improvement in your short-wave reception. ■



The 7106 is a well known IC in the world of A/D converters, and was chosen for three main reasons. Firstly this IC is a 'jack of all trades' and is widely used in all forms of voltage or temperature measuring instruments. Secondly, because it is universally available and relatively inexpensive. Last but not least, the 7106 and its big brother (7116), have so many functions already integrated within themselves that only a few passive components and a LCD are needed to complete a good circuit.

The 7106 contains an A/D converter, clock generator, reference voltage

dependant upon the time. In turn the contents of the counter are then displayed on the LCD. The advantage of using this method is that a relatively simple and straightforward oscillator can be applied. The oscillator frequency of the IC is in fact determined by the values of R2 and C3. This frequency also determines the number of 'samples' taken in every second. As a matter of interest, using the values as indicated in the circuit diagram, three samples are taken every second.

The IC ensures a zero setting before each 'sample', or measurement, automatically. Quite simply, the inputs are

# L.C.D. thermometer

... accurate to 0.1 of a degree

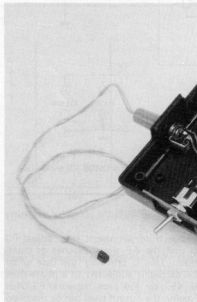

During the past few months, the Elektor offices have been inundated with requests for a digital thermometer.

In answer to all these requests, and to relieve the pressure on our technical queries department, we present a digital circuit using a special IC and a LCD display. The design is inexpensive, but, nevertheless accurate, precise, and has a very low power consumption! The range of the instrument is from  $-50^{\circ}\text{C}$  to  $+150^{\circ}\text{C}$ . The temperature is displayed 0.1 degree at a time, therefore making it suitable for practically any application.

source, BCD-to-seven-segment decoders, and latch and display drivers! Quite a bundle of energy! And even if this array of goodies was not enough, it is also equipped with an automatic zero correction, and polarity indication.

The 7116 (believe it or not), not only has everything the 7106 has to offer, but also includes a hold facility enabling the read-out to be frozen, if required.

The circuit described here is

first of all decoupled internally from the actual input pins and then short circuited. The automatic zero capacitor (C5 in this case) is charged via a separate feedback loop, so that the offset voltages of the buffer amplifier, integrator, and comparator are compensated for, inside the IC. This guarantees any measurement really does start from 0 V, and that when the display reads 000, it does denote a 0 input voltage.

The temperature measurement stage is straightforward if somewhat sophisticated. It contains three voltage dividers: R10 and R11; R8/P1; R9/P2. The junction of the first divider containing the sensor R11 is connected to the 'IN HI' input of the IC. The wiper of potentiometer P1 is linked to the 'IN LO' input and the wiper of P2 to the 'REF HI' input. In effect the circuit measures the differential voltage between one side of the sensor and the wiper of P1. Any measurement is completely independent of the supply voltage level, because the reference voltage of the IC is also derived from the supply (via the divider R9/P2).

Keep in mind that a full scale readout will be equal to twice the reference voltage. Any decrease in supply voltage will not change the readout, because the reference voltage will decrease by the same amount (when compared with the measuring voltage that is). Resistor R4 and capacitor C6 act as an input smoothing filter.

The display is driven directly by the IC. The EXOR gate N2 ensures that the decimal point is activated, by supplying the inverted backplane signal to the corresponding LCD points.

The circuit also has a low battery indication function. The display denotes this by either an arrow or the term 'Low Bat'. An EXOR gate also controls this function!

Transistor T1 is used as a supply voltage level detector. The emitter is connected to the junction of R5 and R7, and its base to the test connection of the IC. This pin not only allows the display

designed to accept either IC, allowing the constructor to decide which of the two he prefers to use.

## The circuit diagram

The circuit as shown in figure 1 is really nothing more than a digital voltmeter, which in turn measures the voltage drop across a temperature sensor.

The dual slope conversion principle is applied for the voltage measurement. Basically the input voltage from the sensor charges capacitor C4 for a fixed period of time. The capacitor then discharges, the rate at which the capacitor is discharged being determined by the reference voltage. The actual time it takes for the capacitor to discharge fully (return to zero) is then proportional to the input voltage level. During the discharge period, pulses from an oscillator are stored in a counter, obviously the number of pulses

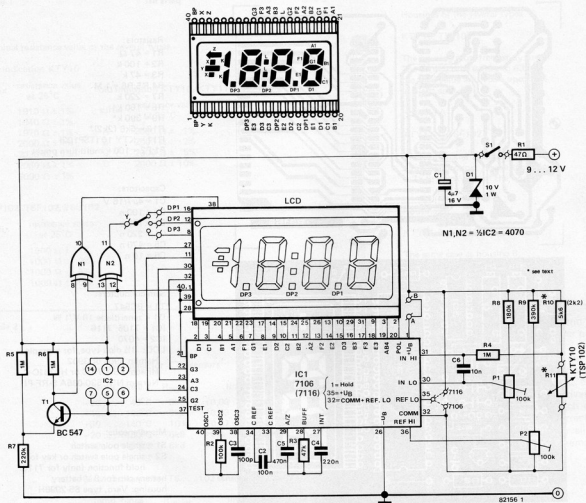

Figure 1. The circuit diagram of the digital thermometer. The circuit is compact, consisting of two ICs and a few surrounding components. A 9 V battery supply is ideal.

itself to be tested (by connecting it to a +5 V supply), but, moreover can provide us with a positive stabilised d.c. voltage! By choosing the right ratio between R5 and R7, T1 will cutoff the moment the supply voltage drops below 7.2 V. As a result the collector voltage of T2 increases, causing N1 to activate the correct notation on the display.

A 9 V battery such as a PP3 is quite sufficient, since the circuit consumes only a few milli-amps. A mains supply is also possible, and it is for this reason that R1 and the zener D1 are added to the circuit.

### The temperature sensor

There are various types of sensors on the market, and the only reason we have picked two particular ones, is that they are inexpensive.

Original tests showed the KTY 10 from Siemens to be ideal, but, as this can be difficult to get hold of, we also tried

the TSP 102 manufactured by Texas Instruments which worked well. Most of the types looked at consisted of a silicon plate, whose resistance depended on the temperature. The only real difference between types was their temperature range. The KTY10, for instance ranged from  $-50^{\circ}\text{C}$  to  $+150^{\circ}\text{C}$ , whereas the TSP was effective over a range from  $-55^{\circ}\text{C}$  to  $125^{\circ}\text{C}$ . The first version has a nominal resistance of  $2000\ \Omega$  at  $25^{\circ}\text{C}$  and the TSP  $1000\ \Omega$  again at  $25^{\circ}\text{C}$ . The temperature coefficient was  $0.75\%/^{\circ}\text{C}$  and  $0.7\%/^{\circ}\text{C}$  respectively. These last figures denoting the resistance increase, per degree celsius, as a percentage over the nominal value.

The accuracy of the circuit is mainly dependant on the width of the measuring range. Which type to use is left to the discretion of the constructor. A serial resistor (R10) is applied (in series with the sensor) in order to stabilise the linearity of the sensor, especially when small measuring ranges

are required. Table 2 provides a summary of several ranges, with the linearity error, and serial resistor values needed. Table 3 describes, in detail, the differing sensors, together with their housing dimensions and type numbers.

### Construction

Figure 2 illustrates the specially designed printed circuit board of the circuit.

The dimensions of the board and the way that the components have been grouped together allow the completed circuit to fit into a case manufactured by Vero (type Nr. 65-2996H). Provision has been made for all the components to be mounted onto the printed circuit board. Constructors should make sure that low profile sockets are used for IC1, IC2 and the display. The display can be inserted into a 40 pin socket which has been sawn in half. We also advise the use of good quality multi-turn presets. As with anything made of glass, great

2

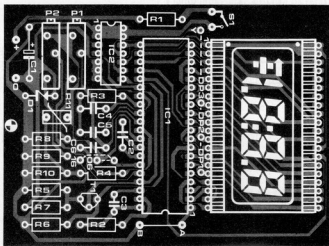
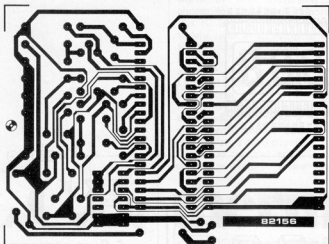

Figure 2. The track pattern and component layout of the printed circuit board. The size and layout of the board allows the completed circuit to be inserted into a ready made plastic case by Vero. Ensure the correct wire links are in place for the 7106 or 7116.

## parts list

## Resistors:

- R1 = 47  $\Omega$   
 R2 = 100 k  
 R3 = 47 k  
 R4, R5, R6 = 1 M  
 R7 = 220 k  
 R8 = 180 k\*  
 R9 = 390 k\*  
 R10 = 5k6 (2k2)\*  
 R11 = KTY 10 (TSP102)  
 P1, P2 = 100 k multi-turn preset

## Capacitors:

- C1 = 4 $\mu$ 7/16 V  
 C2 = 100 n  
 C3 = 100 p  
 C4 = 220 n  
 C5 = 470 n  
 C6 = 10 n

## Semiconductors:

- T1 = BC547  
 D1 = zenerdiode 10 V/1 W  
 IC1 = 7106, 7116  
 IC2 = 4070  
 LCD: 3 $\frac{1}{2}$  digit-type, for example  
 Hamlin 3901 or 3902  
 Hitachi LS007C-C or H1331C-C  
 Norseem NDP 530-035A S-RF-P1

## Miscellaneous:

- S1 = single pole switch  
 S2 = single pole switch or key for  
 hold function (only for 7116)  
 battery clip for 9 V battery  
 housing: Vero, type 65-2996H

\* metal film is preferred

3

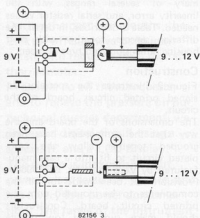

Figure 3. An external power supply can be connected as shown. The battery is automatically switched off when the plug is inserted.

care should be taken when handling the display, especially when inserting it into its socket. Too much pressure on the glass plates may cause the display to appear internally smudged, permanently!

When using the circuit as a normal thermometer, the decimal point DP1 should be connected to point Y by means of a wire link. Obviously, depending on the application, the decimal point can be moved around, by using a rotary or slide switch, if required.

As already stated earlier, the circuit is designed to take either the 7106 or the 7116. For the 7106 wire links are required across points A and B and 06, as shown on the component overlay illustration of the printed circuit board. In the case of the 7116, link 06 is removed and replaced with a link on points '16'. Should you then require the ability to freeze (hold) the display reading, link AB has to be replaced with a simple on/off press button switch.

Keep in mind that this facility is not available when using the 7106.

The sensor can be connected to the circuit by means of ordinary insulated wire, the length of which is not critical. In fact anything up to 30 metres is possible without difficulty. For reliability we suggest encapsulating the soldered connections of the sensor with epoxy resin or glue.

A PP3 type 9 V battery is ideal for the power supply, as it has the advantage of fitting nicely into the battery compartment of the Vero case.

Constructors wishing to feed the circuit from the mains, can install a miniature supply socket next to the battery, to cater for a 9 V mains adapter. Figure 3 clearly illustrates how this should be wired. The battery supply will be automatically cut off immediately a power plug is inserted.

A single bolt or screw with a spacer ensures the circuit is firmly fixed into the case. A piece of clear perspex in the window of the case will protect the

Table 1

Nominal resistance value of the several types

new indication KTY10

suffix	resistance value at 25°C	old indication KTY10, KTY11-1, KTY11-2
-3	1910 Ω ± 1%	suffix
-4	1940 Ω ± 1%	resistance value at 25°C
-5	1970 Ω ± 1%	A
-6	2000 Ω ± 1%	B
-7	2030 Ω ± 1%	C
-8	2060 Ω ± 1%	D
-9	2090 Ω ± 1%	

TSP102, TSF102, TSU102

suffix	resistance value at 25°C
F	1000 Ω ± 1%
G	1000 Ω ± 2%
J	1000 Ω ± 5%
K	1000 Ω ± 10%

Table 2

Serial resistance for KTY sensors

temp. range	R <sub>series</sub>	lin. error
-20 ... +40°C	5k6	+0,08 ... -0,04°C
+40 ... +100°C	8k2	+0,03 ... -0,02°C
+60 ... +140°C	10k	+0,07 ... -0,04°C
-20 ... +130°C	6k8	+0,6 ... -0,6°C
-50 ... +150°C	6k8	+1 ... -1°C

Serial resistance for TS ... 102 sensors

temp. range	R <sub>series</sub>	lin. error
-25 ... +45°C	2k2	---
0 ... +100°C	2k6	+0,05 ... -0,07°C
-55 ... +125°C	2k5	+0,3 ... -0,2°C

Table 3



Housings of the several types

KTY10, TSP102

The housing most frequently used. The setting time is 30 s to 63% of the final value and 150 s upto 99% in silent air.

Housing A

KTY11-1, TSF102

This is a smaller version with screw connection. The settleable time is 7 s to reach 63% of the final value.

Housing B

KTY11-2, TSU102

The same case as housing B, but without screw fastening

Housing C

display. The switches, sockets and so forth can be mounted in the power part of the housing.

The current consumption of the circuit when using the most commonly available sensor (TSP102) is only 2 mA.

Several sensors, which are activated consecutively by a separate switch can also be used. To do this correctly, sensors have to be selected for equality, otherwise errors in measurement readings will occur.

### Calibration

Perhaps we have been a little too quick to explain how to install the circuit into the case, because first of all it has to be calibrated.

Initially the sensor has to be placed into a small cup of chopped melting ice. The cup should contain more ice than water, and the water must cover the ice completely. Give the sensor time to react (about 5 minutes), and turn P1 until the display reads 00.0. P2 sets the scale factor. How this is adjusted depends on the measuring range required. For lower temperatures (-25°C to +45°C), P2 can best be calibrated using a normal thermometer. Insert both thermometers into a bowl of water having a temperature of around 36 ... 38°C, give the sensor a little time to react, and then set P2 so that the reading on the display corresponds.

Higher measuring ranges can be calibrated by suspending the sensor in boiling water, and then adjusting P2 until the readout is 100°C. The only critical aspects of this procedure are to ensure that the water really is boiling and that the sensor does not touch the sides, or bottom of the kettle.

Finally as you have completed the circuit, why waste the hot water. Make a nice cup of tea and relax.

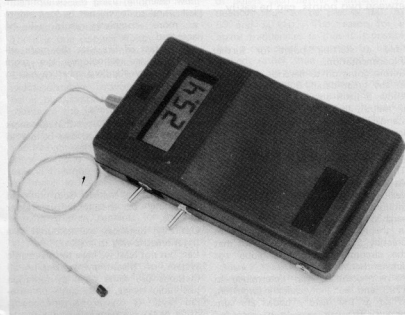

Measuring distances is not difficult, especially when the right equipment is available. Modern technology has certainly done away with the old comical approach of measuring the shelf size by spreading your arms out. For short distances a simple ruler will do, but, in surveying, everything from chains, theodolites, and sonic equipment is used.

The main advantage of using ultrasonic sound is, that the need for any mechanical parts is completely eliminated, simplifying construction considerably.

In practice we found the circuit to be accurate upto about 10 metres, which is very good considering the circuit is

and kept to appeared in 1889, a mere 90 years later. This was made of a mixture of platinum and iridium. It is this reference standard which can be seen in Sevres, near Paris. Rumour, at the time, gave the idea (unjustifiably) that the standard was based upon the height of Napoleon II and as his stature was diminishing with every military defeat, it could not be accepted. For whatever reason (perhaps best left unsaid) the rest of the world continued to search for a more accurate standard. As most of you are aware one particular country in europe (remaining nameless), took nearly 300 years to even come to terms with the fact that a metre even existed.

At the beginning of the twentieth century, scientists started to look at the possibility of using the wavelength of light to define the metre. Consequently the cadmium lamp became the international standard for spectroscopy in 1927. For the uninitiated, this means the study, measurement, and analysing, of rays, light and other phenomena by optical means. The actual unit of length was defined as the Ångström ( $1 \text{ \AA} = 10^{-10} \text{ m}$ ). Even this was not good enough for certain applications, although it is still used as a secondary definition.

The modern standard was established in 1960 using the wavelength of a krypton lamp, which as a matter of interest was not supplied by the famous strip cartoon gentleman.

The metre is defined as equaling 1650763,73 wavelengths of radiation (measured in a vacuum) released by Krypton isotope 86KV during its transition between  $2p_{10}$  and  $5d_5$ . The multiplication factor remained, because scientists still wished to relate the new standard to the old original one.

A new way of defining the standard is now emerging, using the helium-neon-laser, and so it will not be long before a more complex result will be accepted.

It is a fact of life that the more advanced our technology, the more accurate any standard measure has to be.

### Measuring distances

To summarise, the ways that distances are normally measured can be placed into three main categories.

- mechanically
- optically
- electronically

The mechanical method does not need explaining, as the tools are rather obvious.

Optically, distances are measured in a trigonometric way (triangles).

Last but not least we have the electronic system of measurement. Nearly all methods use some form of radiation like radio waves, light, sonic or infrared rays. As the propagation speeds of all of these are known, it is a matter

# ultrasonic distance measurement

## a good starting point for experimentation

There are several ways to measure distances. The method adopted depends not only on what is being measured, but also on your occupation.

The circuit described utilises ultrasonic sound, working on the principle that as, sound travels through the air at a known speed, the time taken and therefore the distance travelled between two points, can be easily determined.

only a starting point for further experimentation.

Before going on to describe the circuit in any great detail, it is interesting to know a little about the definition of a 'metre', and in the various ways the standard has been arrived at over the last 300 years.

### Exactly one metre

The 'metre' started life around 1792. At sometime during that year it was decided to define the standard as: one millionth part of one quarter of the earth's peripheral circumference. Fine in theory, but, totally inaccurate in practice. Scientists soon found out that the circumference of the globe was constantly changing.

A new standard was determined in 1799, and seemingly quickly forgotten, as far as the history books are concerned. The next one to be recorded

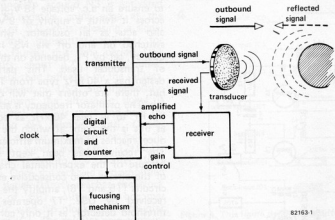

Figure 1. The circuit diagram of a system for measuring distances developed by Polaroid, operating with ultrasonic sound. An ultrasonic pulse is transmitted by a transducer, which then receives the reflected signal. The digital parts of the circuit convert the time taken for the transmitted pulse to travel to and fro, into distances. It then adjusts the camera lens to bring it into focus.

of determining the time taken for a wavefront to travel between two points. Infra-red radiation is mainly used for great distances (a number of miles), as it is relatively simply to modulate. Electronic equipment has been used to measure distances of 60 miles and above, but the effectiveness of such systems depends on a number of factors, such as atmospheric conditions, visibility and so on. With the advent of space technology, lasers are used in combined electro-optical systems to determine the height at which satellites are orbiting the earth.

### In practice

All the methods so far described are mainly used to measure great distances. The average man in the street, certainly does not require sophisticated equipment to decide the size of his living-room carpet, unless of course he lives in a mansion house or castle.

There is one popular hobby in which the accurate measurement of distances is very important; photography! As we all know, it is essential to determine the exact distance between the subject being photographed, and the camera, otherwise the lens cannot be adjusted correctly for focus. The industry supplies quite a lot of aids and equipment which overcomes this problem.

Most cameras utilise some form of optical trigonometric system, with two or more indicators within the view finder which have to be aligned by rotating the range adjustment of the camera. Reflex cameras for instance, use a complex network consisting of a fronted glass, a wedge frame and tiny prisms.

During the last few years, a number of manufacturers have introduced the automatic focusing camera. Quite a few employ a system of mirrors and prisms, with an electric servo motor

moving the lens accordingly. Some are even equipped with an infra-red LED and lens enabling the camera to be automatically focused at night. A recent development, worth a closer look is the new sophisticated system introduced by Polaroid.

### The Polaroid system

When considering automatic focusing cameras, the Polaroid system is something really special, in as much as it is the only one using ultrasonic sound. A large honey-comb patterned gold coloured disc on the outside of the camera casing acts as the transducer (transmitter/receiver) for the sonic pulses.

Figure 1 illustrates the actual distance meter contained within the camera.

The transducer sends out a 'burst' of 1 ms duration. This consists of a series of pulses each having a different frequency, four to be precise (60, 57, 53 and 50 kHz). The reason for so many frequencies is that it is possible for a particular frequency to be absorbed, rather than reflected, by the subject being photographed. The chance of this happening depends on the shape and material of the topic. So, rather than putting all the eggs in one basket, by transmitting four frequencies, the reflection of at least one is ensured.

The transducer then switches over to reception immediately the burst has been transmitted. The reflected signal it receives is then amplified and fed to a digital circuit which determines the time interval between transmission and reception. The circuit processes the signal and in turn controls a servo mechanism, which adjusts the lens to the correct focus setting. The gain of the receiving amplifier can be varied (in 16 steps), dependant on the distance the signal (burst), has had to travel. Obviously the greater the distance between camera and subject, the weaker the signal.

The system is proven and therefore functions well and accurately. It is effective up to a maximum of 10 metres, which is more than sufficient for normal photographic purposes.

### The ultrasonic distance meter

The Elektor design team have combined their thoughts, together with the ideas contained in the Polaroid innovation to come up with an ultrasonic distance meter.

As mentioned earlier sound, ultrasonic or otherwise has a known speed through air. Therefore the time taken to travel from transmitter to subject and back again can be used to determine the distance. The transmitted 'burst' supplies a start pulse to a counter which operates at the same frequency as the propagation speed of sound in cms per second. The received reflected signal provides the stop pulse. The counter would therefore give the distance over which the Burst has travelled. This value would obviously be twice the distance between the object and the transmitter, so, a simple division by two would give us the correct answer.

Figure 2 illustrates in block diagram form what we have just described; transmitter, receiver, counter with readout, and an oscillator switched on and off by the transmitted and received pulses.

### The circuit diagram

The circuit diagram of the complete circuit is shown in figure 3. The transmitter consists of gates N1 and N2, which together form a bridge circuit. The ultrasonic transducer US1 is con-

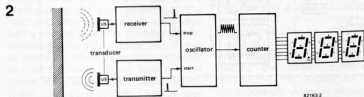

Figure 2. The block diagram of the ultrasonic distance meter. An oscillator starts sending pulses to a counter, when the ultrasonic 'burst' is transmitted. The received pulse stops the oscillator, so that the number of pulses counted indicate the distance measured, (assuming that the correct oscillator frequency was used).

3

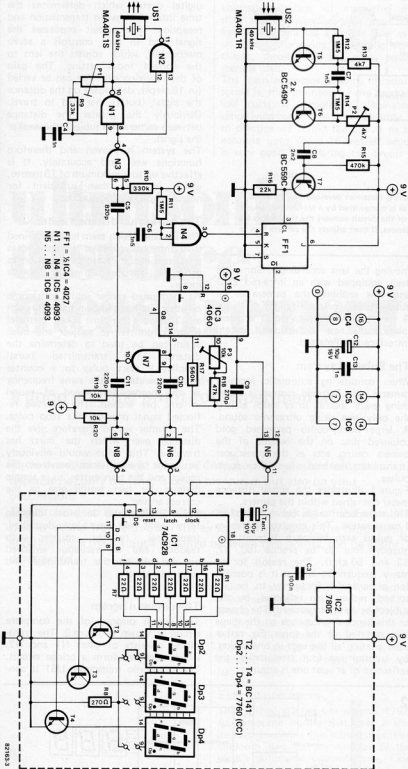

Figure 3. The circuit diagram of the distance meter. The receiver stage is situated at the top left hand side with the transmitter immediately below it. Within the dotted section on the right is the counter and display. The oscillator is constructed around IC3.

nected between the two gate outputs to ensure an a.c. voltage  $18 V_{pp}$  exists across it (with a supply of 9 V). N1 also acts as an oscillator, which is switched on and off via N3. Its frequency, set by P1, depends on the type of transducer used. This particular design has a 40 kHz type from TOKO, but, there are others that will do the job. The oscillator frequency is adjusted by P1 to as near 40 kHz as possible as this is the point at which the transducer reaches its maximum efficiency. The receiver has been kept simple because of the experimental character of the circuit. Two consecutive emitter circuits (T5 and T6), amplify the signal received by P1 to as near 40 kHz as possible. T7 operates as a threshold detector, as it only conducts when its base voltage is lower than the supply (-6 V). To put it another way; T7 conducts when the a.c. voltage (measured at the wiper of P2) exceeds  $1.2 V_{pp}$ . A further oscillator is constructed using IC3 and its surrounding components (R17, R18, P3 and C9). IC3 is in fact a  $2^{14}$  divider with built in oscillator.

The frequency is set to 17190 Hz using P3, since the speed of sound is 343.8 m/s at a temperature of  $20^{\circ}\text{C}$ :  

$$\frac{34380 \text{ (cm/s)}}{2} = 17190.$$

The  $\frac{2}{2}$  digit DVM published in our February 1981 issue is used as a counter with readout. IC1 (counter, latch and display control) directly drives the displays Dp2 ... Dp4, which are multiplexed by IC1 via transistors T2 ... T4. IC2 feeds a stabilised 5 V supply to the counter and display stage of the circuit. IC1 is able to drive 4 displays, but Dp1 and T1 (from original DVM circuit), are omitted, as only three are required here.

Nearly all the other components in the circuit are needed to synchronise the various stages. The importance of correct timing is illustrated in figure 4. This denotes the differing pulses and frequencies present at various points in the circuit.

With an oscillator frequency of 17190 Hz, output Q14 of IC3 will have a signal frequency of approximately 1 Hz,  $(17190/2^{14})$ . This output is connected to the latch input of IC1 via a monoflop (N6, R19, C10) and also to the reset input via inverter N7 and a second monoflop (N8, R20, C11). With the arrival of a negative going edge at Q14, a short pulse is fed to the latch input. A positive going edge at Q14 supplies the reset input with a pulse instead. The signal from Q14 is inverted by N7 and fed to 2 further monoflops; one (N3, R10, C5) driving the transmitter and another (N4, R11, C6) connected to the reset input of flip-flop FF1. The clock input of FF1 is connected to T7 and its  $\bar{Q}$  output to N5. Therefore IC1 gets a reset pulse with every arrival of a positive going edge at the Q14 output of IC3, automatically zeroing the counter. At the same time

the monoflop around N3 is activated (with a negative going edge at the output of N7), thus releasing a signal from the transmitter/oscillator for 0.3 ms. During this time period US1 transmits about 12 (40 Hz) pulses, which are then reflected by the subject, and received by US2. Simultaneously, the moment the ultrasonic signal is transmitted, FF1 is reset and held by monoflop N4 (almost 2 ms). Consequently output Q becomes logic '1' and the signal from the 17190 Hz oscillator is fed to the counter (IC1) via N5. Once the received and amplified sonic signal (burst) reaches the clock input of FF1, output Q becomes logic '0' with N5 blocking the counter input of IC1. The counter now contains the actual distance measured in cms. N6 activates the latch moving the contents of the counter into the latch, which is then displayed. The counter is reset by the next positive going edge at Q14 allowing a new measurement to be taken. The previous readout remains on display until the information from a new measured distance arrives. New readings can be taken every second.

There are some further aspects of the circuit which need a further explanation. US2 will of course pick up the transmitted signal immediately, unless we do something about it. If we do not avoid this the counter will be cut-off straight away defeating the whole exercise. We get over this problem by ensuring that the mono-time of N4 is considerably longer than the time it takes to transmit the 'burst' (2 ms). During this time frame the flipflop remains in the reset position, not caring whether a signal is present at the clock input or not. After the 2 ms FF1 is released so that the circuit does not confuse a reflected signal with a direct one. The only drawback of this inbuilt delay is that distances less than 35 cms cannot be measured, so you will have to rely on a ruler.

The circuit does not include an AGC in the receiver stage or an automatic error compensator (comparing a number of consecutive readings for the same distance), in order to keep it as simple as possible.

### Constructional points to consider

The counter and display stages can be mounted onto one of our ready made printed circuit boards, as listed in the EPS lists as number 81105-1, (first issued in February 1981). Remember that Dp1, T1, C2a and C2b illustrated on the component overlay of this board are omitted. One side of R8 is fed to the decimal point (Dp2) the other to ground. Pin 6 of IC1 must also be connected to ground.

We suggest using veroboard for the rest of the circuit. Keep wiring as short as possible and the transmitting/receiving stages separated from each other. The two transducers are mounted side by

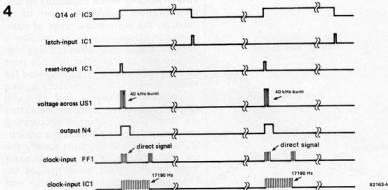

Figure 4. This figure denotes the different pulses and frequencies present at various points in the circuit.

side, (not touching) both facing exactly the same direction. We advise the use of flat 4.5 V batteries as a mains supply may cause stability problems. Power consumption is rather high at 250 mA, but this cannot be avoided when using a LED display. The use of an LCD was discounted as being too expensive for just an experimental circuit. Even so, the batteries should still have a long life simply because the circuit would normally be used a few seconds at a time.

The correct operation of several components and stages can be checked without the need for a scope. Interrupt the connection between N5 and the clock input and connect the latter to pin 4 of IC3 (output Q8). The display should then read 128. When the clock input is shorted to ground the display should read 000. This is a good way to check both the display and oscillator stage around IC3. The transmitting function can be checked quite easily, just by listening to US1. Although the actual 40 kHz signal cannot be heard, the 'burst' will be heard as a soft click, (one every second). Should you happen to hear Radio 3, then something is certainly wrong. In that case write to us and tell us how you did it! Testing the receiver is not easy, but you can assume all is well when the d.c. voltage at the collectors of T5 and T6 is approximately 4.5 V.

Once all this is done then the complete circuit can be tested and calibrated.

Turn the wiper of P2 to maximum, and take a note of the reading. This is produced by the counter between the reset and latch pulses, which are always half a second apart. It is important to remember that this reading will always be displayed when the receiver does not pick up a reflected signal. Now aim the circuit at an object like a closet, which is one metre away and has a vertical area of at least one metre square. Slowly rotate P2 backwards, until a certain point is reached when the display reads approximately 1 metre. Should this not occur and the read out is in the range of 40 to 60, then the transducers will have

to be placed further apart, and a higher value capacitor used for C6. Once a setting of P2 is arrived at, which corresponds to a reading of 1 metre, we can go on to the next stage, which is to set the 40 kHz frequency.

Keeping the circuit in the same position, rotate P2, clockwise until the display is blank. Now rotate P1, until a reading is once again displayed. This procedure is repeated until it is no longer possible to blank out the display by any further adjustment of P2. Reposition the circuit a measured distance of let us say 5 metres from the subject and reset P2 only until the correct reading is displayed.

Finally position the circuit an exact distance (3 metres) always from the same subject, and adjust P3 until the display indicates the correct reading, and that is it!

We obtained very good results with the prototype. The accuracy was  $\pm 2$  cm at a maximum distance of 7...8 metres. The accuracy is dependent on the ambient temperature, air pressure and humidity, as these factors, influence the speed of sound. The range of the instrument can be extended by increasing the gain of the receiver and by increasing the transmitting voltage. Equipping the meter with an offset adjustment (to correspond to the length of the meter housing), will allow wall to wall measurements.

This particular design can also be used in a car, so that the driver is always aware of the distance between himself and a wall or other vehicle. Very useful when trying to park! In fact this idea has already been put into practice by certain manufacturers. Any reader wishing to do this can modify the circuit quite easily by substituting the display for an acoustic indication. A series of rapid beeps, which increase in number as the distance decreases, until a continuous tone is heard, advising an immediate halt, (unless you want to pay the repair bill that is).



When deciding which capacitors to use, consideration should be given to reliability, the permissible range of operating conditions, size and so on. Size is important especially when building high density circuits, and last but not least price. Keep in mind, that, any need for special current limiting resistors is going to increase the overall cost of using tantalums. Even so, tantalum capacitors are used widely, where the operating characteristics of the capacitor is critical. Quite a few Elektor circuits specify the use of tantalums, and not just because they are small and good to look at. They have a stable capacitive value, and a long shelf life. The impedance is virtually unaffected by frequency changes. So, on the face of it tantalums are ideal. However, they do have one major drawback; price!

applications, and certainly fell down, for high frequency designs.

From the offset for many applications the tantalums did not have too much competition, and with the craze for miniaturisation they filled a need straight away. The biggest factor initially in favour of tantalums was this question of shelf life. Even after years of storage, their current leakage, and value remain unchanged. In fact their shelf stability is about 100 times better than the wet aluminium type.

Apart from everything so far explained the tantalums were not embarrassed by temperature. The wet electrolytics are affected quite considerably by temperature, causing large increases in the leakage current level. It is this failure to dissipate heat that causes their mediocre conductance.

# electrolytics run dry

everything you wished to know!

So far for many industrial and professional applications wet electrolytics and tantalums have ruled the roost. With new innovations and technological advancements, it is now possible to use alternatives which can be cheaper and more reliable. Many factors need consideration when making the right choice, and a good knowledge of the merits and limitations of the different types available is useful.

In fact a comparison shows that the new solid aluminium electrolytics, can be used as alternatives for tantalums, and in many respects can be seen to be better.

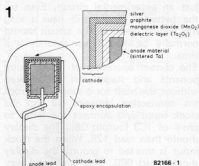

Figure 1. Diagram of the structure of tantalum electrolytic.

With such an incentive as this, some type of alternative was needed.

With the constant improvement in technology, coupled with energy saving and the conservation of natural resources, many experts started to question the sanity of using tantalum for capacitors. Tantalum is now in limited supply, as with everything else, and its price is increasing by leaps and bounds. So, why use tantalums?

We must first of all keep in mind that at the time that they emerged onto the market, the only other type, with which they could be compared, were the wet aluminium electrolytics. These were and still are inexpensive, but are generally larger than any solid counterpart and suffered from a relatively short shelf life. By this we mean, that after long storage, their leakage current increases, and can only be restored to its original value by post-forming. Also, if they are used close to their maximum operating temperature, their life expectancy, which is normally far less than solid types, is curtailed even more. The wet type could not be used in certain new

By comparison the tantalums have a wide operating range as far as temperature is concerned, making them suitable for filters and oscillators. Hence the reason why they are widely used in Elektor designs.

Most of you by now must probably think that the writer must be completely sold on tantalums. Not so! They do have, what can be termed as inconveniences, rather than faults or disadvantages:

- The voltage level they can sustain when connected the wrong way round is extremely small, even for a very short interval. They breakdown rapidly and can explode easily.
- Their a.c. voltage performance is poor and further diminished at high frequencies and temperatures.
- The charge/discharge rate resistance is  $3 \Omega/V$ , making it necessary to use series resistors.
- A surcharge, whether it is of a thermo, current, or voltage nature, will cause immediate breakdown, short circuiting and a possible explosion.
- The price of each item is quickly approaching prohibitive levels.

All in all tantalums are certainly not perfect, mind you what is these days!

Should series resistors not be used in order to limit the charge/discharge rate, then the results are always fatal. This is because field crystallisation will occur, causing short circuiting.

At the beginning of the article we explained all the advantages of using tantalums; impedance, heat dissipation, life span, high frequency performance and so on. But, it seems that it did not take us very long to arrive at the conclusion that even these are not as good as we would wish. As with many things, it is a fact of life that the more you use something the less appealing it becomes. Notice that we do not say everything,

since the good things in life are always welcome.

Luckily the capacitor manufacturers have not stood still and have come up with a relatively new development. Using deeply-etched foil an axial-lead solid aluminium electrolytic has been created, achieving a high CV density making them less expensive replacements for tantalums. Although they are not going to depose the latter completely, they will be very widely used in a variety of industrial and professional equipment.

### Solid aluminium capacitors

The solid aluminium electrolytic has a comparable performance with the tantalum type, but not only is it cheaper, but it does have a few advantages.

Figure 1 shows the different com-

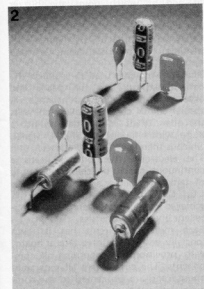

Figure 5. Stability of the main electrical parameters of the three types of electrolytic as a function of time. The curves are for a 0.1  $\mu$ F item measure at 85°C.

ponents which go to make a tantalum. There are a lot of similarities in construction with the solid aluminium type (SAL). Looking at figure 1, you will note that the former has layers of silver, graphite and manganese dioxide ( $MnO_2$ ) which form the cathode. Then comes a dielectric layer and finally the anode made of tantalum. This is sintered to the tantalum oxide (dielectric layer). Figure 3 shows the make up of a SAL. The cathode is composed of the same materials as the tantalum. The real difference between the two lies in the fact that, the anode is composed of deeply etched aluminium and that the dielectric layer is aluminium oxide  $Al_2O_3$ . Hence the remarkable conductivity of the solid aluminium electrolytic! These SALs, to coin a phrase, are very robust to say the least. They can operate near their maximum temperature ratings

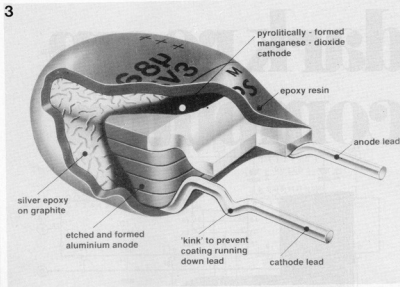

Figure 3. Structure of a solid aluminium electrolytic.

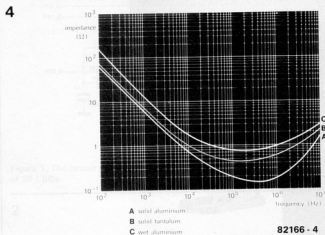

Figure 4. Impedance as a function of frequency with capacitor type as a parameter. All capacitors are 33  $\mu$ F, 10 V.

without shortening their life span, and do not have any catastrophic failure mechanism. In other words they are not going to blow-up in your face at the wrong moment. An added bonus is the fact that series resistors are not needed. The values already available are in the range 47...1000  $\mu$ F and one major manufacturer has proposed to make smaller ones with 0.22...47  $\mu$ F, but, it may take some time before these are available. They are slightly larger than their equivalent counterparts, and although being less expensive than tantalums they are marginally more costly than the wet type. Present applications include telecommunications, space programs, and power stations. Their small size and robustness make ideal for the automobile industry. Because they are being improved upon all the time, a rosy future lies ahead of

them.

To summarise the main characteristics of the SAL are:

- Lower price.
- Their voltage rating remains unchanged throughout the operating range, even at high temperatures (-80 to 175°C).
- The allowed d.c. voltage (reversed) is around 33% of their rated voltage.
- Does not require current limiting.
- a.c. voltages (up to limits) can be handled and do not adversely affect their performance.
- Their impedance fall more steeply with increasing frequency than any other type.
- They can withstand 50/100 Hz a.c. voltages up to a level which is 80% of their d.c. rating.
- Temperature stable, and low failure rate coupled with longevity.

# darkroom computer

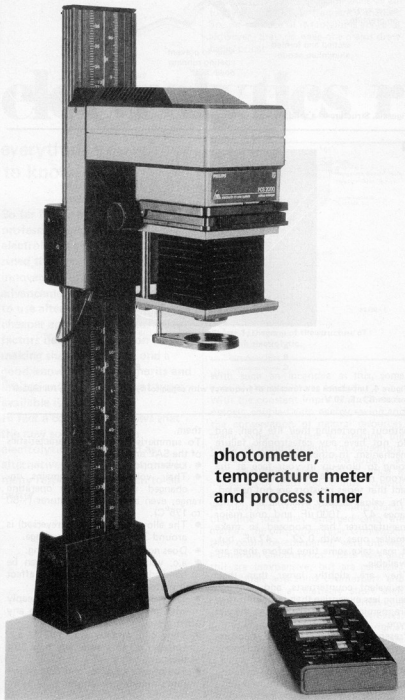

photometer,  
temperature meter  
and process timer

Readers who have already read the 'instructions for use' in the previous issue, will have a pretty good idea of the capabilities of the darkroom computer. However, before all the available features can be used the necessary accessories have to be constructed. In this case there are three such circuits; to measure light, temperature and a time/sequence indicator.

The processor timer is little more than a box containing a series of LEDs in a line giving an optical indication of the passing of time. After all, it is nice to know how much longer a particular photograph has to remain in the development tank of bath, rather than panic at the last moment when the acoustic alarm is heard. The rows of LEDs, in effect, indicate the amount of time that has elapsed since the start button was pressed. How long each LED remains lit and at which point the buzzer sounds is determined by the computer. The alarm can sound after 15 or 25 LEDs have consecutively lighted, depending on the time frame decided upon.

The light meter is used to establish the correct exposure of the paper and check the contrast of a negative. A special colour corrected diode converts the quantity of light it detects into a pulse width modulated (PWM) signal, which is then fed to the computer.

The electronic thermometer keeps a continuous check on the temperature of tanks and baths, and is accurate to  $\pm 0.1^\circ\text{C}$ . This kind of accuracy is achieved by using a sensor with excellent linearity properties.

Each individual circuit has its own specially designed printed circuit board, with provision for mounting all components. The circuits are all separately housed and are connected to the computer with multi-way ribbon cable.

## The process timer

The circuit of the process timer, as illustrated in figure 1, consists of 25 LEDs and two four-to-sixteen decoders. The address inputs of IC1 and IC2 are connected to lines PB0...PB4, whereas, the LEDs are connected to outputs 1...15 of IC1 and 0...9 of IC2. The operation is straightforward. The binary code (which LED lights when) is fed to lines PB0...PB4. PB4 is logic '0', enabling IC1, that is to say as long as the binary number is below 16. When the binary number is between 16 and 25, then PB4 will be logic '1' and IC2 will be enabled.

The LED display is multiplexed in the interests of the power supply. During 2.5 ms the first code for the first LED is put onto lines PB0...PB4, and during the next 2.5 ms the code for the second and so on. If only one LED is 'running', during the second time period a '0' will be on lines PB0...PB4, and as output 0 of IC1 is disconnected nothing will happen.

The set-reset flip-flop, constructed around N1 and N2, is on the left-hand side of the circuit diagram. This flip-flop really acts as a noise suppressor for switch S1, and is linked to the NMI connection of the processor. Depressing S1, the flip-flop supplies the NMI line with a negative going edge, which starts the process timer program and lights the first LED. Pressing S1 a second time starts a second LED 'running' at a time interval from the first, enabling two processes to be timed. If S1 is then depressed a third time, nothing will happen. Programming the timer is described in the constructions for use published in the previous article (part 1). The oscillator and piezo buzzer is activated when a logic '1' appears on line PB6. Potentiometer P1 adjusts the output volume of the buzzer.

One aspect of the total process timer is important. After having read both articles it becomes apparent that there are in fact two timers. One, let us call it the second one is included in the computer, whereas, the first (a separate one) forms part of the remote circuit. This first timer works completely independently of the second and therefore the computer, which allows all the other facilities to be utilised without interruption; light and temperature measurements, the running of the second timer and so on.

### The light meter

As can be seen by looking at the circuit diagram in figure 2, the light meter is the smallest accessory. However, it would be a mistake to assume that it is also the simplest. After all the differences in light levels to be measured in any darkroom are going to be very small indeed! It is therefore essential to have a good quality sensor such as the BPW 21. This particular photo diode has almost the same light and colour sensitivity as the human eye, which makes it also suitable for colour definition measurements. Further more its conversion of light to current is extremely good, as far as linearity is concerned (range of  $10^{-2} \dots 10^5$  lux). A photo diode reacts very quickly to changing light conditions, in contrast to light dependant resistors (LDRs) which need a considerable amount of time to adjust especially in low levels of light.

The current flowing through the photo diode is proportional to the intensity of light. So that the processor can handle the information, the current has to be converted into some form of digital signal. The simplest solution was to use a current to PWM converter. A closer look at figure 2 may give the idea that the photo diode is short circuited, after all it is connected between the ground and the inverting input of IC1. This is correct, because this forms a virtual earth connection due to the feedback loop via IC1. This technique is used to ensure that the operation of

1

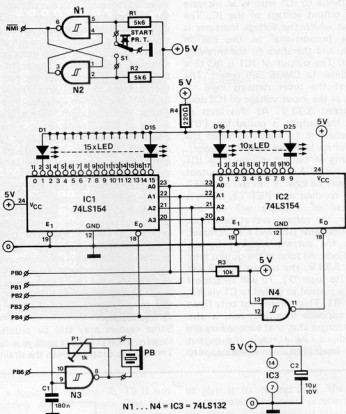

Figure 1. The circuit diagram for the process timer. The passage of time is displayed by means of 25 LEDs.

2

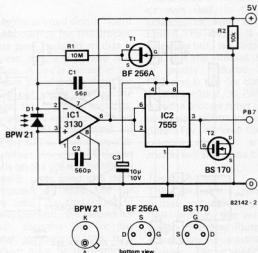

Figure 2. The circuit diagram of the light meter. The somewhat unconventional use of T1 is explained in the text.

the diode is independent (as much as possible) of ambient temperature changes. The current supplied by the photo diode to IC1 ensures an increase in the output voltage of the IC. The speed at which the voltage increases is directly proportional to the rise in current, and therefore to the intensity of light. The output of IC1 is fed to a 7555 timer (a CMOS 555 timer). The input of the timer remains logic '1' as long as the input voltage of IC2 does not exceed 3.33 V. At this level or higher, the output is pulled low ('0'), only returning to logic '1', when the input voltage becomes 1.66 V or lower. Supposing an output voltage from IC1 slightly below 1.66 V, then the output of IC2 will be logic '1'. In this case FET T2 will conduct and FET T1, which is connected as a diode will cut off. However, the voltage level at the output of the integrator (IC1 and C1) increases, due to the current supplied by the photo diode. As soon as the output level reaches 3.33 V, the output of IC2 will change (to logic '0'), T2 will switch off causing a current to be fed to C1 via R2, T1 and R1. This current not only flows in the opposite direction, but, is also much stronger than that supplied by the photo diode. As a result the output voltage level of IC1 will reduce, very

quickly. Consequently when the output of IC1 reaches 1.66 V, the output of IC2 will return to a logic '1', causing T2 to conduct and T1 to cut off again. As the current from D1 is integrated, the output voltage increases again starting the complete sequence all over from the beginning. The events just described are repeated continuously. The point of all this, is that it establishes the fact that the output of IC2 only remains as logic '1' during the integration of the photo diode current. Therefore the length of time during which a logic '1' situation exists is proportional to the intensity of light detected by the photo diode. The greater the intensity the shorter the time!

The only thing left for the processor to do is to decide upon the width of the pulses in order to calculate the right exposure time. The processor determines the average value by sampling the pulses supplied during 2 seconds. In this way any measurement cannot be influenced by any 100 Hz modulated light source, such as the lamp of the enlarger. Remember that this lamp is controlled by a 50 Hz a.c voltage supply.

Some readers may still be puzzled as to why a FET (T1) is used as a diode. The voltage drop between the drain and

source of T2 is still a few millivolts when it is conducting. Therefore T1 prevents any current flow through R1, no matter how small. Should current flow via R1 any measurement will be cancelled out, since the current through the diode is still about 100 pA, with low levels of light. At low voltages, a FET connected in this way has a much lower voltage leakage than any normal diode. For example at 200 mV, a BF256A used in this way has a current leakage of 20 pA, whereas a 1N4148 would have about 12 nA! Quite a difference!

With such low current levels a very low leakage integration capacitor is also necessary. A type which has a time constant of more than 100 s should be used for C1. In other words the internal leakage resistance multiplied by the capacitance must exceed 100 s. The input current of IC1 is typically 2 pA, with a supply voltage of 5 V, which means it does not need to be taken into consideration (negligible).

### The thermometer

The electronic thermometer also works under the same principle of pulse widths. The sensor in this circuit is an LM 335, which is in effect a temperature sensitive zener diode. The voltage

3

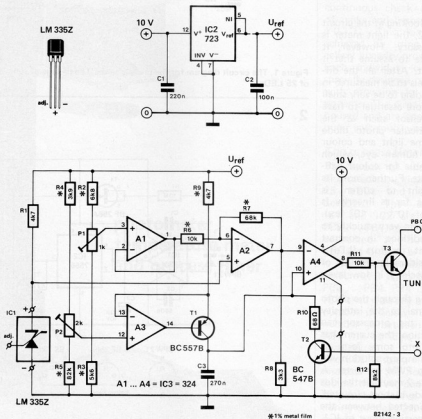

Figure 3. The circuit diagram of the light meter. The resistors marked with an asterisk should be metal film with a 1% tolerance to ensure accurate readings.

4

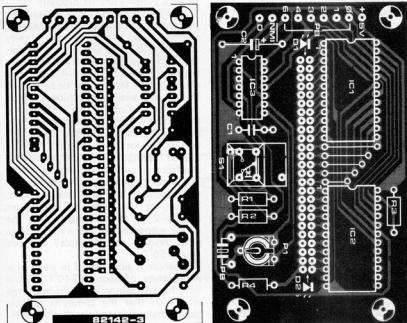

Figure 4. The printed circuit board for the process timer has been designed to fit the BOC 430 case from West Hyde.

supplied by this diode in mV is equivalent to ten times the temperature in degrees kelvin, so that at 0°C (273 K) the diode voltage is 2.73 V. The sensor is accurate over the measuring range 15 to 50°C, which is ideal for use in darkrooms.

Figure 3 illustrates the circuit diagram of the temperature meter or thermometer. The voltage drop across the sensor is applied to the positive input of A2. Under normal conditions the gain of A2 is set to approximately 8 X. Opamp A1 supplies a reference voltage, determined by P1, to the inverted input of A2. Preset P1 is adjusted so that the output of A2 is 0 V at a temperature of 10°C, and 800 mV at 20°C. This output is then fed to the inverted input of a comparator A4. The other input of A4 is connected to a linearising capacitor C3. This capacitor is charged with a constant current source, fed via A3, T1, R4, R5, R9 and P2. When the voltage level across C3 exceeds that from the output of A2, the comparator A4 causes T3 to conduct. In effect, the time it takes for C3 to be fully charged is what we are interested in as this is proportional to the temperature.

Once T3 conducts, C3 discharges via T2, which you will notice is connected in parallel to C3. The base of T2 is in turn connected to the X terminal of the darkroom computer. The processor supplies, via this line, 10 pulses per second, during the measuring period. This pulse train causes T2 to conduct and C3 to discharge ten times a second.

With a logic '0' on line X, T2 is not conducting and C3 charges. The time taken between a logic '0' on line X, and when '0' appears at the output of T3 on line PB0, is used to determine the temperature. It is in effect this information that is digested and processed by the computer, which then shows it as a temperature reading on the display.

## Construction

### Process-Timer

Figure 4 shows the printed circuit board and component overlay for the process timer. This has been designed so that it can be mounted into a BOC 430 case from West Hyde. A slot is needed in the top of the case to accommodate the LEDs (25). Do not forget to make the necessary holes for the press-switches. For a graduated scale and indicator we suggest two strips of card fitted on either side of the LEDs. On the one side a series of numbers (for the LEDs), and process periods on the other. The photograph in figure 5, gives good idea as to how this proposal will look. For the prototype we used, the first block to denote the development, the second for the stop bath and the last for the fixer. In order to keep to this time frame, the alarm must be programmed to sound when the 10th, 13th, and 19th LED is on.

### Temperature meter

Figure 6 illustrates the printed circuit board for the temperature meter, or

## Parts list for the process timer

### Resistors:

- R1, R2 = 5k6
- R3 = 10 k
- R4 = 220 Ω
- P1 = 1 k preset

### Capacitors:

- C1 = 180 n
- C2 = 10 μ/10 V

### Semiconductors:

- D1 ... D25 = LED
- IC1, IC2 = 74LS154
- IC3 = 74LS132

### Miscellaneous:

- S1 = digitast switch
- PB = piezo buzzer Toko PB 2720 (Ambit)

to give it its correct title, the digital thermometer. The sensor is remote from the circuit. Care should be taken to ensure that the LM 335 is wired correctly. Only the centre (+) and the negative pins are used. The ADJ connection is not required and can be cut off. The terminals and soldered joints of the sensor should be encapsulated in epoxy resin. This ensures against short circuits and increases the reliability factor, (see photograph in figure 7).

The printed circuit can be mounted into its own case, in the main computer housing, or even within the process timer! The choice is left to the constructor, but, we suggest the latter. In this case the amount of external wiring is greatly reduced, because points PB0 and 0 can be combined with connections +10 V, X, PB0, NMI, +5 V and 0 of the process timer into one length of multi-way ribbon cable fed to the computer. Try and keep the cable as short as possible, although, anything up to 2 metres will not cause problems.

### The light meter

This is again a completely separate section and is the last accessory we will deal with in this article. The printed circuit board as illustrated in figure 8, is assembled in a rather unconventional manner. The components are in fact mounted on the track side of the board while the other side completely covered in copper. This acts as the earth plane and the front face of the housing. Screening from outside interference is of paramount importance for the circuit



Figure 5. This photograph of the process timer illustrates one example of the timing card.

to operate correctly and, for this reason, the entire housing is constructed of copperclad board. The sides, ends and top and bottom of the case are simply soldered together. As the top (or front face) of the housing is the printed circuit board, this must be assembled before the rest of the case is fitted together. Care must be taken when mounting the components on the board as the risk of short circuits is high with this type of construction. However, the efforts are well worth while as the end result is very effectively screened and, incidentally, can also look very neat if care is taken.

Remember that, although the sensor is mounted inside the case on the same side of the board as the rest of the components, it must protrude slightly through the board (sensor opening) enough to prevent it from being shielded. It can be fixed in place by the use of epoxy resin (or similar) but, be warned, an overzealous application of the 'sticky-stuff' can affect the sensitivity enough to prevent the circuit from operating at all. This was learned by experience on one of the prototypes.

It will be noticed that there is just one small hole through the printed circuit board. This may appear as though somebody started to drill all the holes through and then thought better of it! Not true of course. An off-cut of wire is fed through the hole and soldered both sides in order to earth the earth plane! Don't overlook this step or it will effectively nullify the whole exercise.

If the construction seems a little complex the illustration in figure 9 will clarify matters. The top and bottom of

the case have the copper surface facing outwards while on the ends and sides it is facing inwards. Construction may be aided by the use of a vice to hold the parts together while soldering.

If your finished case is an excellent example of the art of air-tight boxes it is your own fault... the connecting wires to the microprocessor should have been fed through a hole in one end before completing the box!!

### Calibration

The only circuit requiring calibration is that of the temperature meter. The link next to C3 on the printed circuit board of the temperature meter must first be removed. A power supply of between 3 and 10 volts (a 4.5 V battery if necessary) is connected to pin 11 of IC3 and earth (negative to pin 11). At this stage the temperature meter is connected to the computer but the latter is switched off. Further requirements for the calibration procedure are a voltmeter, a thermometer and a developing tray of water.

The voltmeter is connected across resistor R8 and the sensor is placed in

the tray of water. This is where the thermometer comes in. The water must be at a temperature of precisely 10°C. This will not be particularly easy but persistence will pay off in the long run. A thermometer that is very clearly readable will make the job a lot easier. Unfortunately, the majority of domestic thermometers do not fall into this category. The sensor must be suspended in the water without touching the sides or the bottom of the tray. After giving the sensor a little time to settle down, adjust P1 until the reading across R1 is 0 V. Two or three attempts may be needed before results are considered satisfactory.

The temporary power supply can now be removed and the wire link replaced. Switch on the computer and enter MEAS,-2 on the keyboard. With the sensor suspended in free air, the computer reading should display between 10 and 50°C.

The sensor is now placed in water at a temperature of about 35-40°C. Allow time for the sensor to adjust and then set P1 so that the computer reading corresponds to that of the thermometer.

### Parts list for the temperature meter

#### Resistors:

- R1 = 4k7
- R2 = 6k8 1% metal film
- R3 = 5k6 1% metal film
- R4 = 3k9 1% metal film
- R5 = 82 k 1% metal film
- R6 = 10 k 1% metal film
- R7 = 68 k 1% metal film
- R8 = 3k3
- R9 = 4k7 1% metal film
- R10 = 68 Ω
- R11 = 10 k
- R12 = 8k2

- P1 = 1 k multiturn preset
- P2 = 2 k multiturn preset

#### Capacitors:

- C1 = 220 n
- C2 = 100 n
- C3 = 270 n

#### Semiconductors:

- T1 = BC 557B
- T2 = BC 547B
- T3 = TUN
- IC1 = LM 335Z (National)
- IC2 = 723
- IC3 = 324

### 6

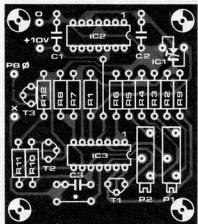
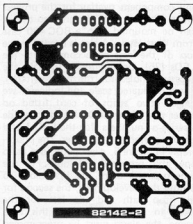

Figure 6. All the components for the temperature meter, with the exception of the sensor, are mounted on this printed circuit board.

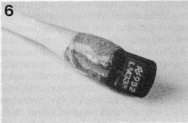

Figure 7. The two pins of the LM335 sensor that are used should be encapsulated in epoxy resin as shown here.

#### Parts list for the light meter

##### Resistors:

R1 = 10 M  
R2 = 10 k

##### Capacitors:

C1 = 56 p ceramic  
C2 = 560 p  
C3 = 10  $\mu$ /10 V

##### Semiconductors:

T1 = BF 256A  
T2 = BS 170  
D1 = BPW 21  
IC1 = 3130  
IC2 = 7555

8

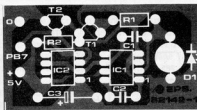
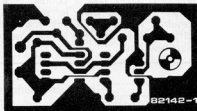

Figure 8. Care should be taken with the assembly of the light meter printed circuit board. As explained in the text, all the components are mounted on the same side as the track pattern.

9

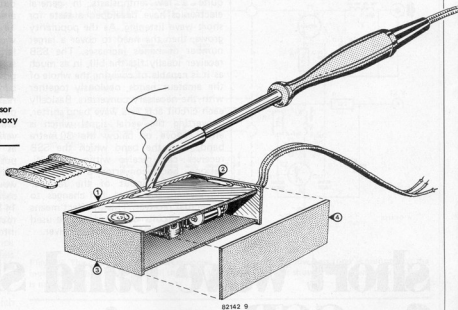

Figure 9. The construction of the light meter case is illustrated here. The printed circuit board forms the top face.

#### In practise . . .

Before dashing off to the darkroom and locking yourself in, it must be decided what times the different processes are going to take so that a process timer card can be drawn up. As an example we are going to use time factors associated with black and white photography. These can be 1.5 minutes for development, half a minute for the stop bath and one minute for the fixing bath. This is in fact the timing shown in the photograph in figure 5. Keeping in mind that the time from one LED to the next is 10 seconds, then the 'alarm' LEDs will be numbers 10, 13 and 19.

Pressing the START PR. T key will now begin the process time. However, it may be that a second timing procedure is required if, for example, a black and white film is to be developed. The timing for this can be 6 minutes for development, 1 minute for wash, 3 minutes for the fixing bath and then a 30 minute wash. In order to carry out this sequence the memory in the main computer will have to be programmed accordingly. Remember that up to 10 different time periods are available. The programming procedure for this has been covered in detail in the user instructions in part 1. Keep in mind the fact that it is also possible to program acoustic signals during the processing sequence. These will be a short beep for each LED with a longer buzz for the end of each period.

A point in part 1 that may need further clarification is the multiplication factor relating to the light meter. Moving the sensor to different areas of the enlarged image will obviously change the light level falling on the sensor. If a number of positions are checked the computer can provide an average reading.

Another method that may be used requires a sheet of opaque tracing paper placed between the enlarger lens and the sensor. The image will of course be out of focus but a good idea of the average light level can be found in this manner. An 'average' negative must be used in order to arrive at a correction factor.

The paper in use is also an important factor when determining the exposure time. Therefore, by experience and the information of the materials used, an error adjustment (or multiplication factor) can be arrived at and entered into the computer which will then compensate accordingly. This factor need only be entered once as long as the same materials are used. This is really no different to any normal manual procedure only that, in this case, once the factor is found and entered into the computer it can be forgotten (after making a note of it!). The method of entering the multiplication factor into the computer was described in detail in part 1.



Since we published the SSB receiver article in June of this year, it is apparent from all the letters received, that quite a few enthusiasts in general electronics have developed a taste for short wave listening. As the popularity grows, then the need to cover a larger number of bands increases. The SSB receiver ideally fits the bill, in as much as it is capable of covering the whole of the amateur bands, obviously together with the necessary converters. Basically each circuit acts as a wave band shifter, converting the aerial signal which is either above or below the 20 metre band, into the band which the SSB receiver can receive without modifications. Each converter is connected to the aerial input of the receiver eliminating any need for changes to the actual receiver. This in effect means that the circuits described can be used with virtually any short wave receiver.

is then mixed together with the frequency from a fixed crystal oscillator to give a number of frequencies at the output (of the mixing stage). Since we are only interested in signals lower than 14 MHz and because the first filter only very roughly separated out the particular band in question, a second filtering stage is necessary. This now extracts the product of frequencies (in the right band) which are required. The basic reason why we use a crystal for this purpose is because they are easily available and relatively cheap. For the very low frequency bands (VLF), such as 10...140 kHz, which are also possible using this technique, things are slightly different. In this case we would use a crystal which gives an oscillator frequency slightly below the 14 MHz band, and then the result is that the summed up frequency comes into the desired band. In this case the

# short wave band shifting for SSB receivers

## from 14 MHz to 14 metres!

The article deals with and describes front ends which can be used with any short wave receiver, specifically the SSB described in our June issue, effectively extending the coverage of the amateur bands. One circuit is designed to convert the band below the 14 MHz 'up' into the required receiving range with the second converting down from higher frequencies again into the 14 MHz band. It is also possible to cover the 2 metre band using this technique. The circuits, as their name implies (front ends) can simply be connected to the input of the SSB receiver. The number of circuits required will only depend on the number of bands constructors wish to cover. Component values are given enabling up to 13 converters to be built, plus of course the original 20 metre band already in the SSB! This is a good way to increase your band coverage in nice easy stages.

### Lower than 14 MHz

One of the simplest solutions for these wave lengths, is to use a band-pass filter, followed by a mixing stage which is in turn followed by another band-pass filter. The first filter is used to extract only the required wave band. This signal

first stage becomes a simple low-pass filter.

Figure 1 shows how a double 'deck' wafer switch is used to select the required wave-band, assuming all the different converters (one for each band) have been built.

1

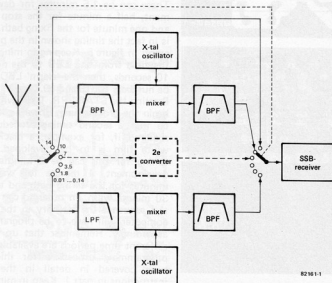

Figure 1. Building five 'up' converters, allows the reception of five extra amateur wave bands (above 14 MHz).

Figure 2 shows the complete circuit diagram for a lower than 14 MHz converter as just described, which is in other words an 'up' converter. The part of the circuit in the bottom left hand corner which includes C1...C6, L1 and L2 is the band-pass filter which caters for 1.8, 3.5, 7 and 10 MHz. Directly above this section is a stage consisting of C7...C10, L3...L5, which is the low-pass filter for the VLF. The component values needed for differing bands are shown in table 1. This is followed by the simple passive mixing stage constructed around the FET BF256C. This FET acts as a switch, which is controlled by the crystal oscillator built around T2. The sum and difference of the product of the filtered input frequency and the oscillator frequency, appears at the output of the mixer. The frequency from the crystal for the 1.8, 3.5, 7 and 10 MHz is chosen so that the difference of the product from the mixer falls into the 14 MHz band (which can be dealt with by the SSB receiver). For the very low frequency band 10...140 KHz, it is the sum of the frequencies which comes into the correct band. The value required for the crystal is for each case listed in table 1. The output of the mixer is then fed to a band-pass filter which ensures that only the 14 MHz band is brought to the input of the SSB receiver.

The input impedance of the converter with band-pass filter is 50  $\Omega$  and that of the VLF-one, 1 to 2 k $\Omega$ . The latter higher value ensures that a simple aerial (single piece of wire) will still provide adequate reception for that band. The loss in signal strength as a result of using a converter is 6 dBs, with a loss in the filter stage of 2 dB, which is very small.

### Higher than 14 MHz

The converters for anything higher than 14 MHz can be used right up to the 2 metre band! Figure 2 once again shows the circuit in block diagram form. The input stage is the same as before; a band-pass filter. But, then instead of going straight to a mixing stage an amplifier is included. From then on the sequence is identical, that is, as far as the block diagram is concerned. When the circuit itself is described in greater detail you will see that this is not the case. Again a crystal oscillator is used, but, in this case a further buffer stage has been included. The circuit diagram is shown in figure 4. The component values for the band-pass stage depend on the wave band required, and are shown in table 2. After the filter there is the amplifier T1 which is followed by a further filter set up in the same manner as the first (L3, C8, C9). A mixer follows this, with T2 being controlled by a crystal oscillator. Finally there is a buffer stage with T4. For all the wave bands listed in Table 2 the values have been calculated on the basis of the

2

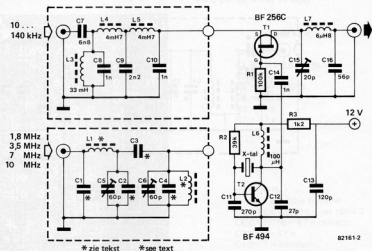

Figure 2. The converter for low frequencies. For VLF bands, a low-pass filter is mounted at the input (upper box insert). For all the other low bands the filter shown in the lower box section is used.

3

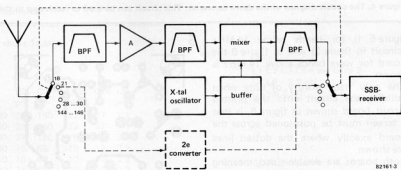

Figure 3. Block diagram for the down converter (above 14 MHz). Although this seems simpler than the circuit shown in figure 1, it does illustrate the principles used.

Again a separate converter is required for each band and a multi-way switch can be used to change the wave band.

Table 1. The component values for converters for lower than 14 MHz.

Band MHz	L1, L2 $\mu$ H	C1 nF	C2, C4 pF	C3 pF	X kHz
0.01 ... 0.14	—	—	—	—	14000
1.8 (160 m)	27	3.3	180	33	16200
3.5 (80 m)	8.2	3.3	180	15	18000
7 (40 m)	2.2	2.2	180	10	21300
10 (10 m)	1	1.5	150	6.8	24300

difference between the oscillator and the aerial input frequencies. After the buffer stage comes the last band-pass filter, ensuring only signals within the 14 MHz band are fed to the receiver. At the foot of table 2 there is a separate box giving the component values needed for the 2 metre band. In this case a 65 MHz crystal is used, and the buffer stage also operates as a frequency doubler.

In the 2 metre version the gain of the converter is between 6 and 12 dB, and in the others approximately 4 dBs. In the latter versions the gain can be boosted by increasing the value of R3, but, then the value of L3 has to be lowered and C8 also increased.

### Construction

Figures 5 and 6 show the printed circuit boards for all converters. The board in

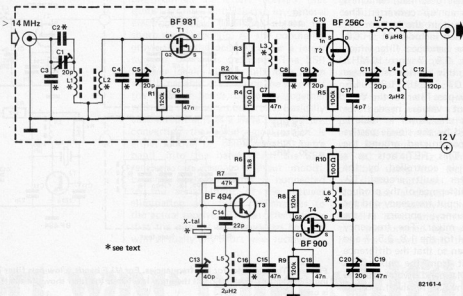

Figure 4. The circuit diagram of the down converter. This circuit can be used to receive up to the 2 metre band (144-146 MHz).

figure 5 is for bands below 14 MHz (circuit in figure 2) and in figure 6 the board for wave bands above 14 MHz is shown.

The only item worthy of note when building the circuit onto the printed circuit board shown in figure 5, is that a screen must be positioned across the board exactly where the dotted lines are shown.

Both boards are double sided, meaning that the component side is a copper plane which must be earthed.

The only really difficult circuit to build is the 2 metre version in as much as, the coils (L1, L2, L3) have to be wound by hand. L3 is the simplest coil to make, as it has only one turn, but L2 and L3 both have 4 windings each, so please take care. These coils must also be inductively coupled, which means they have to be mounted side by side and end to end, and not at right angles, (as shown on the layout). There is plenty of room allowing all this as some of the components, namely C2 and C4, are not needed for the 2 metre version. Figure 7 gives a clear illustration of this. A screen is also required on this board, to separate the input stage from the rest. The dotted lines as shown in figure 6 indicate where this is positioned. We suggest that all, the completed circuits are mounted into screened boxes. Although this involves a considerable amount of work the final results fully justify it.

#### Alignment

High frequency designs (RF) need great care when aligning. However, the

5

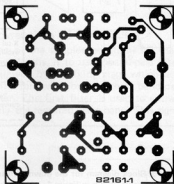

Figure 5. Printed circuit board for the lower frequency converter. The component side is a copper plane.

#### Parts list for below 14 MHz

##### Resistors:

R1 = 100 k  
R2 = 39 k  
R3 = 1k2

##### Capacitors:

C1, C2, C3, C4 = see table 1  
C5, C6 = 60 p trimmer  
C7 = 6n8  
C8, C10 = 1 n  
C9 = 2n2  
C11 = 270 p  
C12 = 27 p

C13 = 120 n  
C14 = 1 n ceramic  
C15 = 20 p trimmer  
C16 = 56 p

##### Coils:

L1, L2 = see table 1  
L3 = 33 mH  
L4, L5 = 4,7 mH  
L6 = 100 μH  
L7 = 6,8 μH

##### Semiconductors:

T1 = BF 256C  
T2 = BF 494

##### Miscellaneous:

X = crystal (see table 1)

6

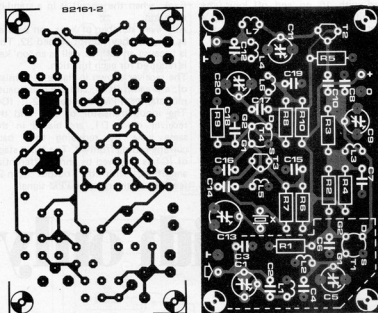

Figure 6. The printed circuit board for the down converter.

Table 2. The component values for converter for above 14 MHz.

Band MHz	L1,L2,L3 $\mu\text{H}$	X kHz	C2 pF	C3 pF	C4,C8 pF	C16 pF	L6 $\mu\text{H}$
18.068 ... 18.168	2.2	32200	33	150	22	27	3.3
21.0 ... 21.450	1.5	35450	33	150	22	22	3.3
24.89 ... 24.99	1.5	39000	27	150	18	18	3.3
28.0 ... 28.5	1	42500	15	68	10	12	2.2
28.5 ... 29.0	1	43000	15	68	10	12	2.2
29.0 ... 29.5	1	43500	15	68	10	12	2.2
29.5 ... 29.7	1	44000	15	68	10	12	2.2

Components for the 2 m-band

L1,L2 *	L3 *	X kHz	C2,C4,C8 delete	C3 pF	C16 pF	L6 $\mu\text{H}$	L7 $\mu\text{H}$	R3 delete
4 wnd	1 wnd	65 000	delete	33	3.3	0.22	1.5	delete

\* 0.6 mm enamelled copper wire, 8 mm  $\phi$ , see text

Resistors:

- R1, R2, R8, R9 = 120 k
- R3 = 1 k
- R4, R10 = 100  $\Omega$
- R5 = 100 k
- R6 = 1k8
- R7 = 47 k

Capacitors:

- C1, C5, C9 = 20 p trimmer
- C2, C3, C4, C8, C16 = see table 2
- C6, C15, C19 = 47 n ceramic
- C7, C18 = 47 n
- C10 = 1 n ceramic
- C11 = 20 p trimmer
- C12 = 120 p
- C13 = 40 p trimmer
- C14 = 22 p
- C17 = 4p7
- C20 = 20 p trimmer (see text)

Coils:

- L1, L2, L3, L6 = see table 2
- L4, L5 = 2,2  $\mu\text{H}$
- L7 = 6,8  $\mu\text{H}$

Semiconductors:

- T1 = BF 981
- T2 = BF 256C
- T3 = BF 494
- T4 = BF 900

Miscellaneous:

- X = crystal see table 2

7

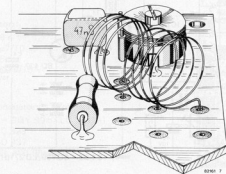

Figure 7. In the 2 metre version the coils L1 and L2 must be wound by hand and are inductively coupled.

Parts list for above 14 MHz

alignment of the circuits so far described is not critical and is certainly straightforward. It is just a matter of adjusting all the trimmers until the maximum signal-to-noise ratio is achieved. Obviously as with any normal aligning procedure, every time one trimmer is set, it will influence the other, therefore each should be adjusted in turn (several times) until the correct alignment is achieved.

One final comment concerns the trimmer C13 in circuits catering for frequencies above 14 MHz (figure 4). This is used to ensure that the oscillator frequency is exactly what is required, getting rid of any discrepancies in the crystal frequency.

Figure 1 illustrates the circuit diagram of the transmitter. It contains; a keyboard with 16 on and off keys, the transmitting IC, and final stage. A 9 V battery such as the PP3 is ideal for the supply.

A command given by depressing a key is immediately converted into a corresponding E-D-C-B-A 5-bit binary code. We have purposely left the detailed explanation of how the code is allocated till later, as any reference to it as this stage could confuse the issue.

The 5 bit code, which is nothing more than a pulse sequence of 6 identical signals, is transmitted by modulating the infra-red diodes D1 and D2. The actual information, is hidden in the

operational switch, ensuring that the power consumption does not exceed 6  $\mu$ A, when the circuit is in a stand-by situation.

Any even number of keys can be used as long as they do not exceed 32. This is because an 'off' as well as an 'on' key is required for each function.

The receiver shown in figure 2, consists of; a preamp (IC1), and the pulse pause modulation (PPM) decoder, IC2...IC4. The input transistor of IC1, and the receiver diode D1, are biased in the same way, by receiving their base current setting from T1. The input stage of IC1 is followed by three differential amplifiers, with the output (pin 2) feeding out the received PPM signal.

# 16 channels with only five ICs

There have been many circuits published for infra-red remote control systems of varying complexity. The design here however, while still providing 16 channels, keeps construction fairly simple by utilising special ICs produced for the purpose by Plessey. In fact, the circuit is similar to that found in many domestic television sets.

Control is by means of push buttons, and both the transmitter and receiver can be made very compact.

gaps, or breaks between pulses. A short pause denotes logic '1', a long one a logic '0'. Pulse and pause duration can be set with the aid of trimming potentiometer P1. Keep in mind that a logic '0' pause is about 1.5 times longer than a logic '1', and that each pulse is approximately 3 ms. There is preset delay period of 54 ms between any two different commands. Infra-red radiation is only possible when pin 3 of IC1 is pulled low. This is the only way that a current 'pulse' or surge (lasting about 15  $\mu$ s), will flow through T2 and the diodes. As a matter of interest this can be as high as 8A!

The IC contains an internal electronic

## PPM decoder

ICs ML 928 and 929 can be found in various kinds of circuits, although they were originally designed for use in TV sets. They each contain; a PPM demodulator, time base generator (together with an oscillator), and a shifting register with following latches/memories. The binary information is in fact, located at the output of the latches. Apart from all this, there is an integrated comparator taking care of the error correction, automatically! So, under normal conditions nothing can go wrong, what so ever! Each IC is able to digest and process 16 commands converting the received information into

1

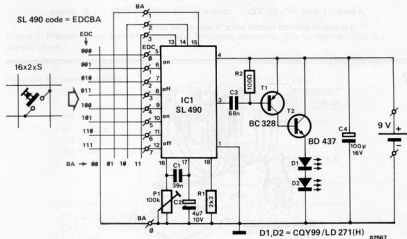

Figure 1.

The transmitter consists of; a keyboard, transmitter IC, final stage and a 9 V battery.

2

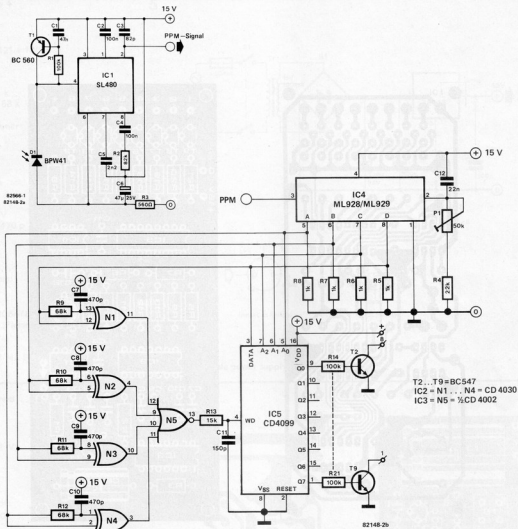

Figure 2. The receiver consisting of; a pre-amp with IC, PPM decoder (IC2... IC4).

## Parts list figure 3

## Resistors:

R1 = 2k2  
R2 = 100 Ω  
P1 = 100 k trimmer

## Capacitors:

C1 = 39 n  
C2 = 4μ7/10 V  
C3 = 68 n  
C4 = 100 μ/16 V

## Semiconductors:

D1, D2 = CQY 99 or LD 271(H)  
T1 = BC 328  
T2 = BD 437  
IC1 = SL 490 (Plessey)

## Miscellaneous:

Reflector for D1/D2  
9 V battery

3

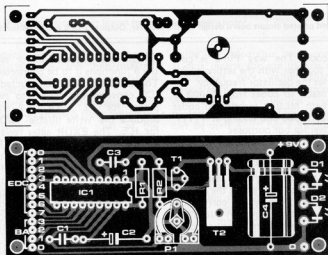

Figure 3. A suggested track pattern and component overlay design for the printed circuit board of the transmitter. The LEDs are equipped with a reflector for a stronger light beam.

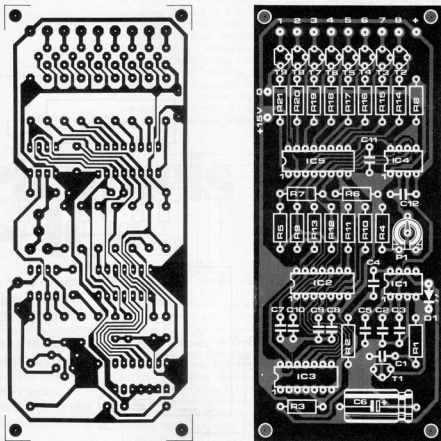

Figure 4.  
A suggested printed circuit board design for the receiver. Outputs 1 to 8 can be connected by means of a multi-way socket.

binary code. The way Pin 2 is connected, together with the setting of P1, determines the oscillator frequency.

ML928 reacts to codes from 00000 to 01111, with ML929 reacting to codes starting at 10000 and ending at 11111. This is ideal for our purposes.

In order to control a total of 16 functions both ICs are needed. Only one decoder is required when only 8 functions are sufficient. In this case, care must be taken to ensure that the correct codes are allocated which correspond to the keys being used. An allocation can easily be derived from the keyboard matrix shown in figure 1.

The 5-bit code is transmitted by the sequence E-D-C-B-A and interpreted by the receiver accordingly. Column E denotes which of the two ICs it is meant for ('0', ML928, '1' ML929); D supplies the 'on' or 'off' information; C, B and A

contain the information for which of the 8 functions is to be connected.

The decoding circuit constructed around IC5 converts the code into switching pulses for T2...T9. IC2 and IC3, produce the 'write disable' (WD) pulse for IC5. The EXOR gates register any level changes at the inputs; DATA, A2, A1 and A0. The NOR gate, situates a logic '0' at the WD input. The allocation of the binary codes to the outputs of IC5 and to the switching outputs, is infact, mirrored! This is simply because, IC4 is supplied with a negative operating voltage, enabling it to also function with negative logic. That means, output Q6 and not Q1 is used when the data '001' is situated at A0...A2. Consequently, the switching signal at the DATA input will reach T8 via output Q6. The WD input will be logic '1' and the data input will be blocked when no further switch-

ing information is on the inputs of IC5. The outputs are not affected.

### Construction, calibration, application

We advise constructors to build the circuits with printed circuit boards, the design of which are shown in figure 3 and 4. Unfortunately, due to unforeseen circumstances we are unable to supply ready made ones from our EPS service. However, we feel certain that this will not prove to be a stumbling block for our readers.

The transmitter diodes are equipped with reflectors, which improve the light beam intensity, making it possible to control devices from a range of 8 to 10 metres.

## Parts list figure 4

## Resistors:

R1, R14 . . . R21 = 100 k  
 R2 = 82 k  
 R3 = 560  $\Omega$   
 R4 = 22 k  
 R5 . . . R8 = 1 k  
 R9 . . . R12 = 68 k  
 R13 = 15 k  
 P1 = 50 k trimmer

## Capacitors:

C1 = 47 n  
 C2, C4 = 100 n  
 C3 = 82 p  
 C5 = 2n2  
 C6 = 47  $\mu$ /25 V  
 C7 . . . C10 = 470 p  
 C11 = 150 p  
 C12 = 22 n

## Semiconductors:

D1 = BPW 41  
 T1 = BC 560  
 T2 . . . T9 = BC547B  
 IC1 = SL 480 (Plessey)  
 IC2 = 4030  
 IC3 = 4002  
 IC4 = ML 928/ML 929  
 IC5 = 4099

## Parts list figure 6

## Capacitors:

C1 = 330  $\mu$ /25 V  
 C2 = 330 n  
 C3 = 100 n

## Semiconductors:

B1 = B40C800  
 IC1 = 78L15

## Miscellaneous:

Tr = 16 V/0.1 A mains transformer  
 fuse 63 mA  
 two-pole mains switch

## 5

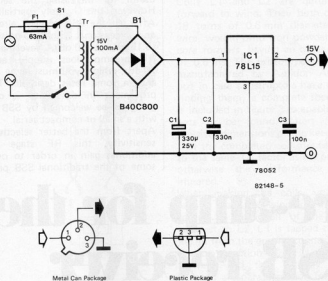

Figure 5. A simple power supply for the receiver.

## 6

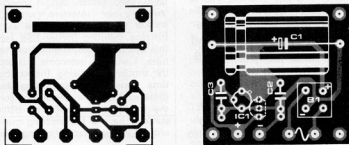
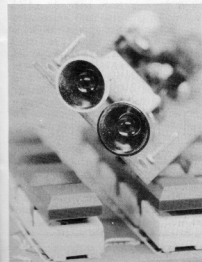

Figure 6. Design and component layout for the power supply board.



A keyboard can be built up on veroboard quite easily, and then inserted, together with the battery and circuit into a plastic case.

The receiver needs a 15 V supply. This can either be obtained from the equipment being controlled, such as the stereo system and so on, or from the power supply illustrated in figure 5. Where you install the receiver will depend on what is to be controlled. Obviously, anyone wishing to control more than one piece of equipment should house the receiver in a separate plastic case, and install separate or one multi-way socket.

The output signals from the unit are suitable for use with relays. As a matter of interest our June 1982 issue described a solid state relay which would be ideal for this application. We suggest the relay is placed near to, or actually

inside the apparatus being controlled, as this means the use of low capacity connection wire, rather than thick obtrusive mains cable. Mechanical relays will require a protection diode connected the reverse way round. Any relay can be used which has a maximum coil voltage of 12 V and a resistance of around 150  $\Omega$ .

The calibration procedure is quite short. Set P1 of the transmitter to its mid position and depress a key (to switch something on). Now adjust P1 of the receiver until the relay is activated. Repeat the procedure a few times until you are satisfied that the relay is activated every time the key is depressed and that is it!



# pre-amp for the SSB receiver

boost the selectivity and sensitivity of your SSB.

In the normal course of events, it is a fact of life that anything good can always be improved upon. It is therefore only natural that we should try to improve a good and successful design such as the SSB receiver published in the June 1982 issue.

An additional MOSFET preamp not only increases the sensitivity, and betters the selectivity but also extends the AGC range.

Improvement just for the sake of change is not a philosophy followed by us. We therefore feel certain that SSB users, especially those with access to large sophisticated aerial systems, are going to appreciate the little extra that the circuit introduced here gives.

Readers may be excused for jumping to the conclusion that the preamp is only useful for increasing the sensitivity. However this is only partially true. After all the SSB receiver already has an exceptional signal-to-noise ratio (0.15  $\mu$ V at 10 dB). Nevertheless the RF preamp does supply an extra 10 dBs, which, you must agree is useful and in some cases desirable. This improvement in sensitivity is certainly going to be welcomed by SSB owners with a small or compact aerial.

Apart from the better selectivity and sensitivity, this RF stage supplies additional gain in order to overcome some of the traditional SSB problems.

is harder than standing on the beach and trying to stop the tide. And everyone remembers what happened to the last man or king who tried that!

As David did with the proverbial Goliath, we have supplied a subtle and highly effective weapon in the form of an additional band-pass filter at the input of the RF stage. The band-width of this filter is 5000 kHz and together with the filters originally included in the SSB receiver, it provides adequate protection against the 'giants'. In effect the circuit becomes highly selective, thereby muting and damping the overbearing 19 metre transmitters, even when using large, sensitive aerials.

A further advantage of using the RF preamp relates to the ability of the receiver to handle and control high level input signals, (eliminate cross-modulation). Basically we are adapting the principle that the more amplification stages which are controlled by the AGC voltage are used the more effective the AGC will be.

As the AGC voltage controls the gain of the MOSFET, the result is to considerably extend the effective range of the AGC. In practice this increase is about 20 dBs! Strong signals adjacent to weak ones are now 'squeezed' a little more allowing the receiver to handle them much more easily. Consequently the receiver produces less noise when being tuned and has good station separation.

To summarise, the additional RF preamp enable the user to achieve;

- higher sensitivity.
- better selectivity.
- an extended AGC range.

## The circuit diagram

Looking at figure 1 will show that a

Practise has shown that 'strong' transmitters operating within the 19 metre band can, under certain conditions, 'swamp', or interfere with, other weaker stations. Despite the extensive filtering included in our SSB receiver, this will still occur, if only from time to time. Trying to overcome this problem by simply twiddling the controls is time consuming, aggravating and to some extent futile. When you consider the fact that some of these offending stations have a transmitting power of around 2 mega watts, fighting them off

1

L1, L2: 18 turns 0.8 mm enamelled copper wire  
on to AMMIDON T50-6 core  
L3: 2 x 10 turns (bifilar) on to AMMIDON T50-2 core

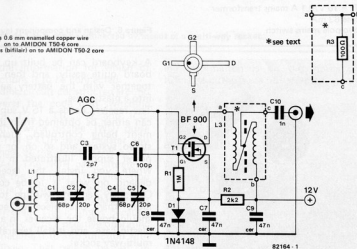

Figure 1. The preamplifier is constructed with a dual gate MOSFET 9f00. The difficult to wind coil, L3, can be replaced by a resistor R3.



An active antenna certainly cannot perform miracles. If, for example, we really do want to receive the 'Voice of the Andes' on 17790 kHz, we really need a resonant  $\lambda/2$  dipole aerial of about 8 m in length. An active aerial with a rod length of about 1.5 m can only be substituted for the dipole as a physical compromise. The following will show how we arrive at this compromise.

half-wave dipoles of up to 95 m in length?

Here we have to go into a little more detail. Atmospheric noise is the factor governing the design of receiving aeri-als. In the case of our half-wave dipole, the atmospheric and industrial noise level is high compared to the noise level of commercially available receivers. Thus, reception quality depends only on the signal itself and the interference received.

If the aerial is shortened, the signal-to-noise ratio is initially constant because, although the signal level is reduced, so is the level of received noise. However, there is a limit to this shortening in length — the point at which the 'electronic noise' of the receiver, which is independent of the aerial, becomes greater than atmospheric noise. Figure 1 shows the relationship between signal-to-noise ratio and aerial length in a graph. In region b, an aerial which is considerably shorter than a 'normal' one, can still be utilized. In this case the received noise level is just as high as that of electronic noise.

Short aeri-als of this type are constructed as vertical aeri-als (rods or whips) and horizontal aeri-als (dipoles) for reception over the range 10 kHz to 30 MHz.

# active aerial

## A short, active aerial for DXers

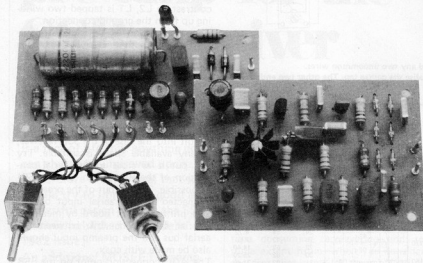

There it is, the new communications receiver. But how do we get it to pick up the "Voice of the Andes"? As the saying goes: a good aerial is still the best RF amplifier. However, the landlord will probably object to metres of wire and suspending the wire around the inside of the home will provoke the wrath of the family. A tangle of wire under the sofa is no solution either. What we need is an active aerial: it should be short and convenient to use whilst enabling good reception. An active antenna certainly cannot perform miracles. If, for example, we really do want to receive the "Voice of the Andes" on 17790 kHz, we really need a resonant  $\lambda/2$  dipole aerial of about 8 m in length. An active aerial with a rod length of about 1.5 m can only be substituted for the dipole as a physical compromise. The following will show how we arrive at this compromise.

### Some radio principles

The problem involves an 'electrically short' receiving aerial for frequencies below 30 MHz, the hunting grounds of the short-wave DXer. But here is the paradox: how can an active aerial with a rod length of about 1.5 m be used over the frequency range of 1.5 — 30 MHz, in which we normally have to utilize

### Matching

So far so good. But why can't we simply connect an aerial to the receiver in the form of a short rod? This can be best explained by figure 1. First of all, the signal level received by the aerial is not greatly reduced when the aerial is shortened. For example, a dipole which is short with respect to wavelength receives only 10% less signal level than the half-wave dipole. The problem is in the question of matching.

In figure 2, the aerial is represented as an AC voltage source with the characteristics  $R_A$  (= radiation resistance) and  $X_A$  (= reactance). At a constant frequency, the radiation resistance is proportional to the square of the length of the dipole. The reactance is inversely proportional to the length. This means that the shorter the aerial, the greater is the reactance. With a short dipole of 10 m overall length, for example, we have the following values at 1.5 MHz:  $R_A$  approximately 0.5  $\Omega$  and  $X_A$  a few kilohms. With proper matching for the transfer of power, however, this total impedance must be exactly the same as the input impedance of the receiver, (50  $\Omega$ ). Considering the aerial itself as a voltage source, and as the impedance increases as it is shortened, then the consequences are severe. Feeding a high impedance unloaded voltage to a low impedance input of a receiver simply means that you will get absolutely nothing out! What is required is a proper match! With passive aeri-als, transformers are employed to correct the miss-match.

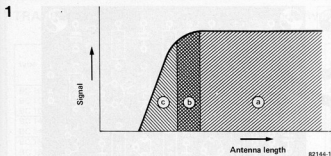

Figure 1. Signal-to-noise ratio as a function of absolute aerial length 1 at a constant frequency, a = region in which the level of atmospheric noise is higher than that of internal noise; b = region in which the level of atmospheric noise is close to that of internal noise; c = region in which the level of internal noise exceeds that of atmospheric noise.

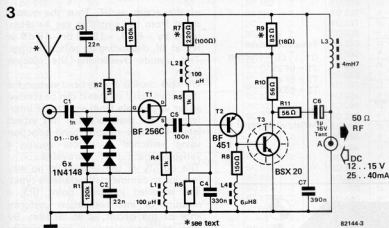

Figure 3. The 'active' part of the aerial consists of impedance transformation stage with T1 and amplification stage with T2/T3. The circuit is 'remote-powered' via the output and L3.

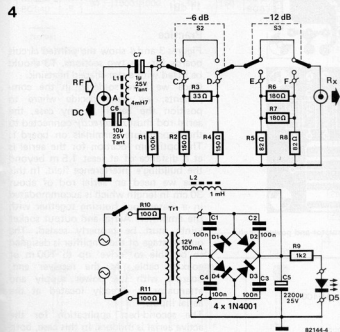

Figure 4. Power supply and attenuator of the active aerial system. The DC voltage is fed into the coaxial cable to the amplifier via L1/L2/C6. Four attenuation stages can be selected with S2 and S3.

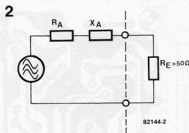

Figure 2. Matching conditions at the aerial output. Equivalent circuit of the aerial: AC voltage generator,  $R_A$  = radiation resistance,  $X_A$  = reactance. Receiver input impedance:  $R$ .

Using this technique on active aerials would also work, but, only over a narrow frequency range.

The solution to our problem is really quite simple! The short high impedance aerial is first of all connected to an amplifier which also has a high impedance input. Thus the unloaded voltage from the source (aerial), is not destroyed. Matching the receiver to the amplifier is achieved by providing the amplifier with a low impedance output.

To summarize, therefore: the secret of the active aerial is that when the short aerial (short with respect to wavelength) is properly matched to a receiver (using an amplifier stage), it delivers exactly the same reception results as its big brother. An added benefit is that it provides advantages in DX reception. The theoretical explanation would be beyond the scope of this article, but it is true to say that from a technical viewpoint, active aerials are a good compromise between high sensitivity and short dimensions.

### The active aerial

The active aerial consists of three parts: impedance transformer and amplifier, power supply, attenuator (see figure 3). The RF part of the active aerial is designed around transistors T1-T3. The passive part, the aerial rod, is applied directly to the gate of field effect transistor T1 via coupling capacitor C1. T1 is configured as a source follower, resulting in the desired performance as an impedance transformer (high input impedance, low output impedance). T2/T3 form a two-stage RF amplifier whose amplification is adjusted by R7 and R9. The amplification can be increased if necessary by varying R7 and R9. In this case, the values in parentheses apply.

The circuit is powered by the remote power supply consisting of Tr1, the bridge rectifier and C5 (see figure 4). The DC voltage is applied to the output of the amplifier via L1/L2/C6. The DC voltage reaches the amplification stages via L3.

The attenuation stages which are selected with S2 and S3 form the third part

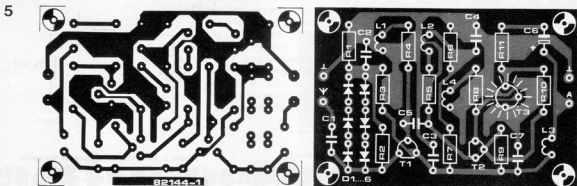

Figure 5. Printed circuit board and component overlay for the RF part of the active aerial. T3 is fitted with a star-shaped heatsink.

#### Parts list for figure 5

##### Resistors:

R1 = 120 k  
R2 = 1 M  
R3 = 180 k  
R4 ... R6 = 1 k  
R7 = 220  $\Omega$  (100  $\Omega$ )  
R8 = 150  $\Omega$   
R9 = 82  $\Omega$  (18  $\Omega$ )  
R10, R11 = 56  $\Omega$

##### Capacitors:

C1 = 1 n  
C2, C3 = 22 n  
C4 = 330 n  
C5 = 100 n  
C6 = 1  $\mu$ /16 V tantalum  
C7 = 390 n

##### Coils:

L1, L2 = 100  $\mu$   
L3 = 4m7  
L4 = 6 $\mu$ 8

##### Semiconductors:

D1 ... D6 = 1N4148  
T1 = BF256C  
T2 = BF451  
T3 = BSX20

##### Miscellaneous:

Aerial rod 30 cm or 1 m

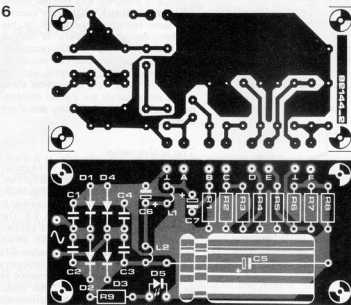

Figure 6. Printed circuit board and component overlay for the attenuator and power supply of the active aerial.

#### Parts list for figure 6

##### Resistors:

R1 = 100 k  
R2, R4 = 150  $\Omega$   
R3 = 33  $\Omega$   
R5, R8 = 82  $\Omega$   
R6, R7 = 180  $\Omega$   
R9 = 1k2  
R10, R11 = 100  $\Omega$

##### Capacitors:

C1 ... C4 = 100 n  
C5 = 2200  $\mu$ /25 V  
C6 = 10  $\mu$ /25 V tantalum  
C7 = 1  $\mu$ /25 V tantalum

##### Coils:

L1 = 4m7  
L2 = 1 m

##### Semiconductors:

D1 ... D4 = 1N4001  
D5 = LED

##### Miscellaneous:

S1 = two-pole mains switch  
S2, S3 = two-pole changeover switch  
Tr1 = mains transformer, 12 V/100 mA secondary

of the active aerial. Thus the output signal from the amplifier can be attenuated by  $-6$  dB,  $-12$  dB or  $-18$  dB or not at all, depending on switch settings. This avoids overdriving the receiver input.

We have chosen a wide-band version for the active aerial so that it can be erected as far as possible from sources of interference. We shall examine this aspect later. For this reason, band selection using switched capacitors and/or a variable capacitor is not provided.

The quality of the aerial is in no way inferior to commercially available types. The so-called intercept point IP3, a measure of intermodulation performance of the circuit, is at 30 dBm. By way of comparison, a commercially available aerial (AD-270/370) exhibits the same value. The frequency range extends from 3 kHz to 100 MHz ( $-3$  dB) with T2/T3 providing a gain of 11 dB!

#### Practice

Figures 3 and 4 show the printed circuit boards for the two sections. T3 should be fitted with a star-shaped heatsink.

Once we have soldered in the components, we must decide where to position the aerial. In any case, the aerial rod must be *directly* connected to the appropriate terminals on board 1. The optimum location for the aerial is at a distance of at least 1.5 m beyond the building's interference field. In this case we need an aerial rod of about 30 cm in length which is accommodated in a waterproof housing together with the amplifier. Aerial and output socket joints must be properly sealed. The output stage of the amplifier is designed to be able to 'drive' up to 100 m of coaxial cable. At the receiver end, board 2 with the power supply and attenuator is directly located at the aerial input.

The second-best application for the active aerial is indoors. In this case, both printed circuit boards and the aerial rod (now 1 m in length) can be installed in a housing.

Now all that is left is to try it out. Have fun and good DXing.  $\blacksquare$

TRANSISTORS SURVEY: AF and general-purpose types.

type	PNP NPN	max U <sub>CEO</sub> (V)	max I <sub>c</sub> (mA)	P <sub>max</sub> (mW)	hFE/I <sub>c</sub> (mA)	compl.	fig.	
BC107	N	45				BC177	1	
BC108	N	20	100	300	>110	2	BC178	1
BC109	N					BC179	1	
BC140	N	40				BC160	1	
BC141	N	60	1000	3700	>40	100	BC161	1
BC160	P	40				BC140	1	
BC161	P	60				BC141	1	
BC177	P	45			>70	BC107	1	
BC178	P	25	100			BC108	1	
BC179	P	20			>110	BC109	1	
BC182	N	50				BC212	2	
BC183	N	30			>100	BC213	2	
BC184	N					BC214	2	
BC212	P	50	200			BC182	2	
BC213	P	30			>60	BC183	2	
BC214	P	30			>80	BC184	2	
BC237	N	45			>140	BC182	2	
BC238	N					BC107	1	
BC239	N	20	100		>110	BC308	2	
BC239	N	50				BC309	2	
BC307	P	45	100		>70	BC237	2	
BC308	P	25				BC238	2	
BC309	P	20	50			BC239	2	
BC327	P	45				BC337	2	
BC328	P	25				BC338	2	
BC337	N	45	500	800	>100	100	BC327	2
BC338	N	25				BC328	2	
BC414	N	50	100	300	>100	2	—	2
BC416	P	30			>120	2	—	2
BC516	P	30	400	625	>30.000	20	BC517	2
BC517	N					BC516	2	
BC546	N	65				BC556	2	
BC547	N	45			>110	—	BC557	2
BC548	N	30				BC558	2	
BC549	N	30			>200	—	—	2
BC550	N	45	100	500		2	BC546	2
BC556	P	65			>75	—	BC547	2
BC557	P	45				—	BC548	2
BC558	P	30			>125	—	—	2
BC559	P	45				—	—	2
BC560	P	45				—	—	2
BC639	N	80	1000	1000	>40	150	BC640	3
BC640	P					BC639	3	

type	PNP NPN	max U <sub>CEO</sub> (V)	max I <sub>c</sub> (A)	P <sub>max</sub> (W)	hFE/I <sub>c</sub>	compl.	fig.	
BD131	N					BD132	4	
BD132	P		3	15	0,5A	BD131	4	
BD135	N	45				BD136	4	
BD136	P					BD135	4	
BD137	N	60	1	8	>40	0,15A	BD138	4
BD138	P					BD137	4	
BD139	N					BD140	4	
BD140	P					BD139	4	
BD169	N	80	1,5	20		BD170	4	
BD170	P					BD169	4	
BD183	N		15	117	>20	3 A	—	5
BD233	N	45				BD234	4	
BD234	P					BD233	4	
BD235	N	60	2	25		BD236	4	
BD236	P					BD235	4	
BD237	N	80			40	BD238	4	
BD238	P					BD237	4	
BD239	N		2	30		0,2 A	BD240	6 2)
BD240	P					BD239	6 2)	
BD241	N		3	40	>25	1 A	BD242	6 2)
BD242	P					BD241	6 2)	
BD243	N	45	6	65	>30	0,3 A	BD244	6 2)
BD244	P					BD243	6 2)	
BD245	N		10	80	>40	1 A	BD246	7 2)
BD246	P					BD245	7 2)	
BD249	N		25	125	>25	1,5 A	BD250	7 2)
BD250	P					BD249	7 2)	
BD435	N	32				BD436	4	
BD436	P				>85	—	BD435	4
BD437	N	45				BD438	4	
BD438	P					BD437	4	
BD439	N	60	4	36		0,5 A	BD440	4
BD440	P				>40	—	BD439	4
BD441	N	80				BD442	4	
BD442	P					BD441	4	
BD643	N	45				BD644	7 1)	
BD644	P					BD643	7 1)	
BD645	N	60	8	62,5		3 A	BD646	7 1)
BD646	P					BD645	7 1)	
BD675	N	45			>750		BD676	4 1)
BD676	P					BD675	4 1)	
BD677	N	60	4	40		1,5 A	BD678	4 1)
BD678	P					BD677	4 1)	
BD679	N	80				BD680	4 1)	
BD680	P					BD679	4 1)	
TIP31	N		3	40			TIP32	6 2)
TIP32	P				>20	0,5 A	TIP31	6 2)
TIP33	N		10	80			TIP34	7 2)
TIP34	P						TIP33	7 2)
TIP35	N	40	25	125	>25	1 A	TIP36	7 2)
TIP36	P						TIP35	7 2)
TIP41	N		6		>20		TIP42	6 2)
TIP42	P						TIP41	6 2)
TIP122	N		8	65		0,5 A	TIP127	6 1)
TIP127	P						TIP122	6 1)
TIP142	N	100	15	125	>1000	5 A	TIP147	7 1)
TIP147	P						TIP142	7 1)
TIP2955	N			100			TIP3055	7
TIP3055	P				>20	4 A	TIP2955	7
2N3055	N	70	15				MJ2955	5
MJ2955	P			115			2N3055	5
2N2955	P	25	100 m	0,3	>20	10 mA	—	1

- Notes:  
 1) darlington  
 2) max. U<sub>CEO</sub>:  
 ... A = 60 V  
 ... B = 80 V  
 ... C = 100 V

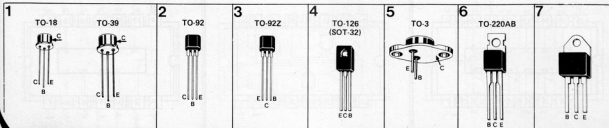

DUAL 3 INPUT NOR GATE PLUS INVERTER

4000

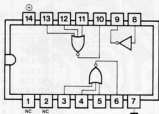

QUADRUPLE 2 INPUT NOR GATE

4001

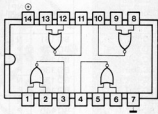

DUAL 4 INPUT NOR GATE

4002

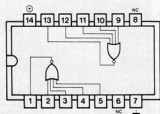

QUADRUPLE 2 INPUT NAND GATE

4001

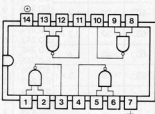

DUAL 4 INPUT NAND GATE

4002

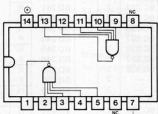

DUAL D FLIP FLOP

4013

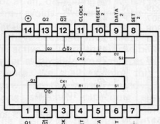

DUAL 4-BIT STATIC SHIFT REGISTER

4015

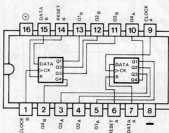

DECADE COUNTER/DIVIDER

4017

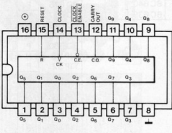

SYNCHRONOUS PRESETTABLE DIVIDE BY 'N' COUNTER

4018

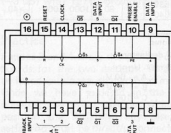

14-BIT BINARY RIPPLE COUNTER

4020

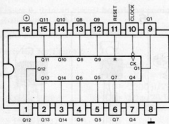

TRIPLE 3 INPUT NAND GATE

4023

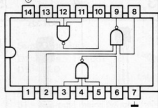

7-STAGE BINARY RIPPLE COUNTER

4024

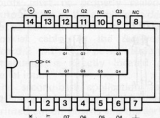

TRIPLE 3-INPUT NOR GATE

4025

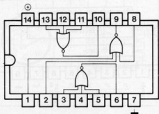

DUAL JK FLIP-FLOP

4027

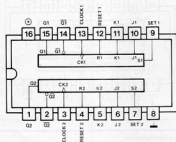

8CD TO DECIMAL DECODER

4028

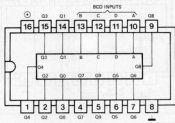

SYNCHRONOUS PRESETTABLE BINARY/DECAD UP/DOWN COUNTER

4029

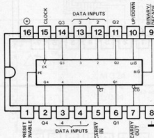

QUADRUPLE 2-INPUT EXCLUSIVE-OR GATE

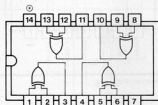
4030  
4070 low power TTL, compatible (see note 2)

4-BIT PARALLEL-IN/PARALLEL-OUT SHIFT REGISTER

4035

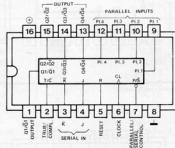

12-BIT BINARY RIPPLE COUNTER

4040

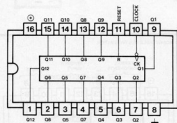

QUAD CLOCKED 'D' LATCH

4042

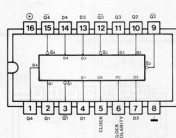

MICROPOWER PLL

4046

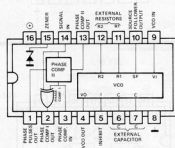

MONOSTABLE/ASTABLE MULTIVIBRATOR

4047

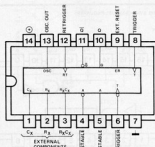

HEX INVERTING BUFFER

4049

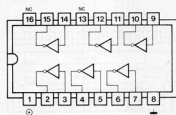

HEX BUFFER

4050

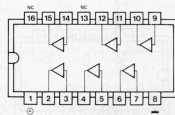



8 CHANNEL ANALOG MULTIPLEXER/DEMULTIPLEXER

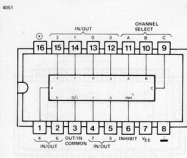

4 SEGMENT LCD DRIVER

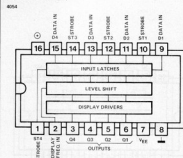

B CD TO 7 SEGMENT DECODER/LCD DRIVER

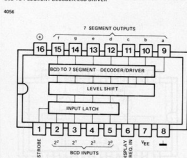

16 STAGE BINARY RIPPLE COUNTER AND OSCILLATOR

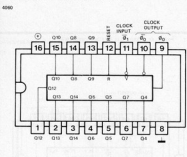

QUAD BILATERAL SWITCH

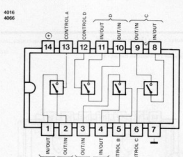

8 INPUT AND/NAND GATE

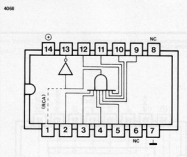

QUADRUPLE 2 INPUT OR-GATE

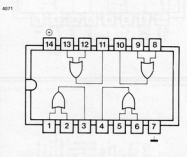

TRIPLE 3-INPUT AND-GATE

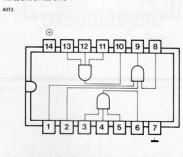

8 INPUT OR/NOR GATE

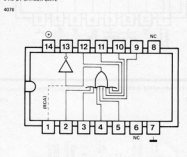

QUADRUPLE 2 INPUT AND-GATE

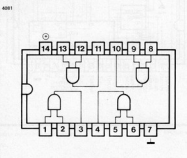

QUADRUPLE 2 INPUT NAND SCHMITT TRIGGER

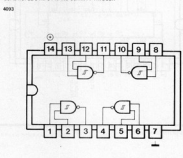

DUAL 4-BIT MONOSTABLE MULTIVIBRATOR

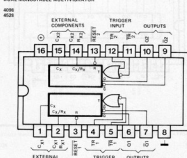

HEX SCHMITT TRIGGER

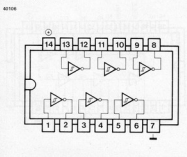

B CD TO 7 SEGMENT LATCH DECODER/DRIVER

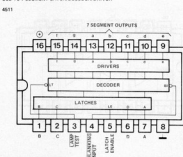

DUAL 4-BIT SYNCHRONOUS UP-COUNTERS

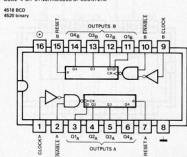

Linear ICs



301  
318  
709  
741  
CA 3130  
CA 3140  
LF 355/356/357  
TL 071/081



1458  
4558



LM 387  
NE 542



LM 324  
TL 074  
TL 084



RC 4136



555



LM 10C

CA 3080



LM 13600

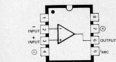
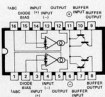

All ICs shown top view

Voltage Regulators



7805  
7806  
7808  
7812  
7815  
7818  
7824

$I_{out} = 1 A$



7905  
7906  
7908  
7912  
7915  
7918  
7924

$I_{out} = -1 A$



78M05  
78M06  
78M08  
78M12  
78M15  
78M18  
78M24

$I_{out} = 500 mA$



79M05  
79M06  
79M08  
79M12  
79M15  
79M18  
79M24

$I_{out} = -500 mA$



78L05  
78L06  
78L08  
78L12  
78L15  
78L18  
78L24

$I_{out} = 100 mA$



79L05  
79L06  
79L08  
79L12  
79L15  
79L18  
79L24

$I_{out} = -100 mA$

$U_{out} = 5 V$



LM 309K  
 $I_{out} = 1 A$   
LM 323K  
 $I_{out} = 3 A$

$U_{out} = -5 V$



$I_{out} = -3 A$

$U_{out} = 1,2 V \dots 37 V$



LM 317K  
 $I_{out} = 1,5 A$

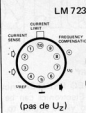

LM 723  
 $I_{out} = 200 mA$   
 $U_{out} = \dots 37 V_{max}$   
(pas de  $U_2$ )  
 $U_{ref} = 7,15 V$   
 $U_2 = 6,2 V$

$U_{out} = 2,85 V \dots 40 V$



L 200  
 $I_{out} = 2 A$

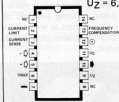

Operating Voltage Range

7805 = 8 V ... 35 V	7905 = -8 V ... -35 V
7806 = 9 V ... 35 V	7906 = -9 V ... -35 V
7808 = 11 V ... 35 V	7908 = -11 V ... -35 V
7812 = 15 V ... 35 V	7912 = -15 V ... -35 V
7815 = 18 V ... 35 V	7915 = -18 V ... -35 V
7818 = 21 V ... 35 V	7918 = -21 V ... -35 V
7824 = 27 V ... 40 V	7924 = -27 V ... -40 V

# missing link

## Home telephone system (Elektor 89)

Extensive tests have shown that improved performance can be realised with a few minor modifications regarding the power supply of the home telephone system. In short, it means lowering the power supply output to 5 V. This really only applies to those systems where a large number of extensions are in use. The modifications to the circuit consist simply of changing a few component values and IC1, the voltage regulator. All other components, including the transformer, can remain unchanged.

The changes are as follows:

R7 = 8k2  
R16 = 1 k  
R18 = 33 k  
R19 = 10 k  
R21 = 820 k  
D7 = AA 119  
IC7 = 7805

All information appearing on the CRT, can be copied quickly and efficiently without modification. Both positive and negative prints can be provided. Compact and lightweight, the electrosensitive dot matrix printer is simple to operate and maintain, printing out on to a 5 inch paper roll at 12 seconds per picture (normal resolution) or 24 seconds per picture (high resolution).

*Thandar Electronics Limited,  
London Road,  
St Ives,  
Huntingdon Cambs.  
Telephone: 0480.64646*

(2483 M)

## Inexpensive LCD multi-testers

Three new LCD digital multi-testers are announced by Semiconductor Supplies, Sutton. These compact, rugged units with 3½ digit LCD readouts have carrying cases and probes and are guaranteed for a year. Prices range from £23.10 to £36.05 (plus VAT). Model KD-55C, at the top of the range, has twenty-eight measuring ranges including 10 amps dc and ac and a foldaway stand for bench use. The display includes polarity, over range, low battery overload indicators. There is automatic zeroing on all ranges.

*Semiconductor Supplies Internation Ltd.,  
Dawson House,  
128/130 Carshalton Road,  
Sutton, Surrey,  
SM1 4RS.  
Telephone: 01.643.1126*

(2484 M)

## Portable oscilloscope

Now available from Matron is the BS-310S dual trace oscilloscope. It is a portable instrument designed for service applications and will double successfully as a bench scope as full Laboratory features are retained. The instrument is small and light weighing 5.5 kgs including internal rechargeable batteries which automatically charge whenever mains

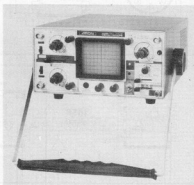

power is supplied. A built-in switching regulator ensures stable performance over wide variations in mains voltage and frequency and for external DC input. Specification includes 15 MHz bandwidth, 2 mV sensitivity chop-act selection, trace add-subtract, 0.5 sec to 0.5 microsec per division timebase with X5 magnifier and variable control, X-Y mode and TV sync.

*Matron Ltd.,  
20 Park Street,  
Princes Risborough,  
Bucks.  
Telephone: 08444.4321*

(2481 M)

# market

## Video printer

The TP55 VIDEO PRINTER, now available from Thandar Electronics can be connected to any standard video source to provide an instant hard copy record print. Operating in response to a composite video signal, it needs no interface. Connection is made via a single coaxial cable offering limitless applications. It is especially suited as an accessory for logic analysers, or microcomputer terminals, with video output.



# market

## Selective-call module

Emu Systems Limited has developed a high quality Selective Calling device with many unique features ideally suited for the CB market. The Emu Selcall's main advantage is its ability to transmit and receive on two different codes, allowing for far greater flexibility when more than two units are in use.

The receive code is programmed internally, whilst the transmit code is selected by three thumb-wheel switches mounted on the front panel.

### Other features include:

1. The ability to mute/unmute the rig by momentarily depressing the Push to Talk switch.
2. A message received light indicates that the unit has been activated during the user's absence, thus requiring a return call.
3. Very short transmit period of typically 100 ms (about one tenth of a second), an exceptionally important point when comparing with other units that require a total silent period on channel of between 5 and 7 seconds. This means that there is little chance of another person corrupting the coded information whilst transmitting.
4. 820 different coded tone bursts are available for use on each channel.

Like all other Emu CB accessories, the Selective Call Unit plugs directly into the microphone socket on the rig, with no need to make any internal alterations. Another feature avoids the need to hold the Unit on or near loudspeakers, microphones etc. — a real push button system!

Emu Systems Limited,  
1 East Street,  
St Ives,  
Huntingdon,  
Cambridgeshire.  
Telephone: 0480.61177

(2478 M)



## Frequency counter

The model 8610B : 600 MHz has a frequency range of 10 Hz-600 MHz in three ranges with a 9 digit LED display with automatic decimal point and LED gate activity indicator. There is a front panel sensitivity control and two separate inputs for added versatility. Switch selectable gate times are: 0.1 second, 1 second and 10 seconds. Setability is  $\pm 2$  ppm and time base frequency is 10 MHz. Power requirement is 4.8 VDC-6.5 VDC (4 'C' cells) or there is line voltage via an AC adaptor. Weight is only 1.3 lbs without batteries.

Stotron Ltd.,  
Haywood Way,  
Ivyhouse Lane,  
Hastings,  
Sussex.  
Telephone: 0424.442160

(2476 M)

micro-switches. With no moving parts, there are obvious advantages in long life, less maintenance and greater reliability.

Switching capacity is 200 mA, with npn or

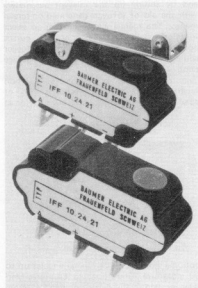

## Inductive proximity switches

The new Baumer micro-switch-size inductive proximity switched are designed as plug-in replacements for conventional mechanical

pnp make or break output, and operating voltages 5 V to 30 V. Intrinsically safe versions are also available. Housing is robust plastic, in case size V3 with 6.3 x 0.8 mm 'Faston' connectors.

Britec Limited,  
Unit 17, Bermondsey Trading Estate,  
Rotherhithe New Road,  
London SE16 3LL.  
Telephone: 01.237.8081

(2475 M)



# market

# market

## Digital oscilloscope

The 4500 digital oscilloscope from Gould Instruments Limited offers a 35 MHz bandwidth on each of its two channels, and is equally suited to high-speed recording of single-shot or repetitive signals and to systems use in automatic testing applications. The instrument's twin 100 MHz digitisers enable it to achieve an absolute voltage accuracy of  $\pm 6.6\%$  maximum over the recorded full-scale range, a resolution of 5.1 bits at 35 MHz, and a transient-response relative error of only  $\pm 0.4\%$  after 40 ns.

The 4500 incorporates an easy-to-use, oscilloscope-like control panel and display, plus an optional facility for computer control via an optional GPIB, RS-232C or fast access Unibus-compatible interface. A fast analogue interface is also included.

In benchtop recording applications, the 4500 can be used in the normal oscilloscope mode and by setting up the relevant parameters with the aid of software-generated on-screen menus. The menus allow the user to select functions such as signal averaging, cursor control, digital interface control, trigger source and filtering, or plotter interface control.

The oscilloscope incorporates calculation facilities to allow mathematical comparison of acquired or reference waveforms, and an

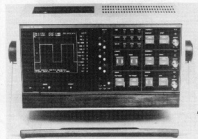

optional floppy-disk peripheral enables up to 30 waveform acquisitions to be stored and later recalled to the display or to an external computer/controller.

The 4500 can be operated in a roll mode, like an oscillographic chart recorder, or in a scroll mode, so that test points can be compared sequentially. For waveform comparisons, it has a reference-memory capacity of 4 kbyte. It also has an acquisition-memory capacity of 1 kbyte per channel in the dual-channel mode, and 2 kbyte if a single channel is used. Up to four sets of instrument set-up parameters can be stored in a battery-backed-up random-access memory. The display makes use of a 500-line vertical raster scan, which not only offers a higher-resolution display with more characters than the traditional flying-spot technique, but also aids the generation of 'menu' displays.

*Gould Instruments Limited,  
Roebuck Road,  
Hainault,  
Ilford,  
Essex,  
Telephone: 01.500.1000*

(2443 M)

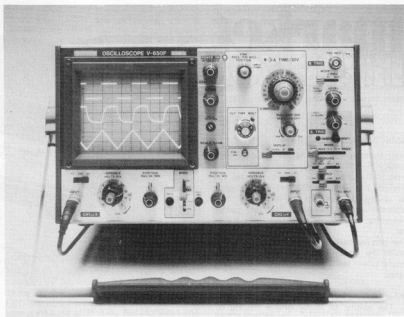

## 3 traces oscilloscope

The V-650F 60 MHz laboratory portable oscilloscope from Hitachi has the facility for displaying three traces simultaneously by way of its versatile trigger-view function which can be used to access a Channel-3 input and display in either alternate or chopped modes. Other features include vertical sensitivity to 1 mV/division, dual timebases with calibrated delay multiplier and full B trigger control variable trigger hold-off and sweep speeds to 5 nsec/cm using the X10 magnifier. The 6½" rectangular CRT has a metal backed phosphor for increased brightness and an internal graticule to avoid parallax errors. Trace sharpness is particularly good.

A new and unusual feature is the Channel-1 output socket which enables a frequency counter, chart recorder or digital storage unit to be driven using the gain or attenuation of the internal Y amplifier.

*Reltech Instruments,  
Coach Mews,  
St. Ives,  
Huntingdon,  
Cambs. PE17 4BN.  
Telephone: 0480.63570*

(2439 M)

## Miniature 5 V thermal printer

The K160 is a 16 column miniature thermal printer mounted on a printed circuit board from Roxburgh Printers. It consists of a print head, the SP 285, on a PCB together with the power supply, drive electronics and interface to a microprocessor bus.

A distinctive feature is that only a +5 Vdc supply is required as an inverter is used to generate the thermal elements' voltage. As the K160 also interfaces directly to an 8 bit parallel bus, incorporating it into a microprocessor system is extremely simple. ASCII data is sent to the K160's customised microprocessor which also controls all timing, drive and character generating functions of the print head. It also has programmable line feed and self test programs. The K160 uses 38 mm wide thermal paper and prints at 1.75 lines per second. The right two columns are offset by one column which can be useful for printing units or exponential powers.

*Roxburgh Printers Ltd.,  
22 Winchelsea Road,  
Rye,  
East Sussex.  
Telephone: 07973.3777*

(2442 M)

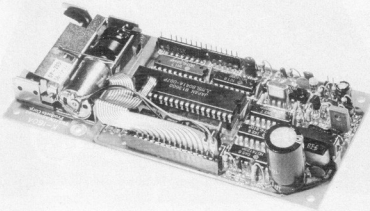

# market

## True RMS 4% digit multimeter

The newly introduced 1504 multimeter from Thurlby Electronics combines true RMS ac measurements with a 4% digit scale length. The instrument is designed for bench or field operation and has a high contrast Liquid Crystal Display with a full scale of  $\pm 32,000$  counts which gives it 60% greater resolution than 4% digit units.

The basic accuracy is 0.05% guaranteed for 1 year and the 1504 can measure dc voltage up to  $\pm 1200$  volts, ac voltage up to 750 V, dc and ac current up to 10 amps, and resistance up to 32 M $\Omega$ . Sensitivity on the 320 mV dc range is 10  $\mu$ V, and voltages up to  $\pm 3.2$  volts can be measured with an input impedance greater than 1,000 M $\Omega$  avoiding loading errors when measuring high impedance circuitry. Maximum sensitivity on dc current is 1 nA, and on resistance is 0.01  $\Omega$ .

All ac measurements are True RMS responding and consequently give a correct reading of the power content of non-sinusoidal waveforms such as those found in thyristor switching circuits. The meter will accept a crest factor (peak to RMS ratio) of 5 at 10,000 counts.

The resistance ranges provide for high accuracy diode test measurements by virtue of their constant current excitation system, whilst the long scale length enables in-circuit resistance measurements to be made across semi-conductor junctions without losing accuracy. The 1504 also features a frequency measurement function which enables pulse waveforms up to 3.9999 MHz to be measured with an accuracy of 0.005% and a resolution of 100 Hz. All ranges and functions are protected against overload to a minimum voltage of 250 V rms. The meter is housed in a rugged ABS bench/portable case measuring 9 in x 9 in x 2 in and weighing 2 1/2 lbs. It can operate from ac line power or from internal

batteries by virtue of its low power consumption. The 1504 is supplied complete with test leads and manual and costs £175 plus VAT within the UK.

Thurlby Electronics Ltd.,  
Coach Mews,  
St. Ives,  
Huntingdon,  
Cambs,  
PE17 4BN.  
Telephone: 0480.63570

(2482 M)

## PCB mounting inductive proximity sensors

Baumer Electric of Switzerland announce the IFR-1082 series of miniature proximity

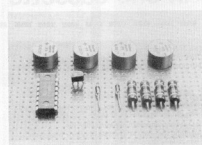

sensor which are ideal for multiple switching applications, and are small enough to be mounted in rows on a PCB: for example to detect the positions of various cams in a bank and for sequential switching. Models with minimum sensing distances 2 mm or 4 mm are available.

The small size, and hence close packing density, make the IFR 1082 series sensors very simple to mount and to design in, and prices are very much lower than conventional inductive proximity devices.

Britec Limited,  
Unit 17,  
Bermondsey Industrial Estate,  
Rotherhithe New Road,  
London SE16 3LL.  
Telephone: 01 237 8081

(2479 M)

## Memory mapped VDU card

A memory mapped VDU card is one of a range of Z80 single Eurocards available from Electronic Hobbies Ltd. The card is of the standard 100 x 160 mm (6 1/8 x 4 in) size and is fully compatible with others in the series. It has a 2K RAM optimised for a 80 x 24 character display and is priced at £305 (plus P&P at £1.75 and VAT). Less sophisticated versions are available from £170.

A display of up to 8,000 characters or 256 x 256 graphic dots can be produced, configured by software from an optional screen memory of 1K to 8K bytes. Similarly text or tables may be generated with from 20 to 128 characters per line and up to 64 lines display.

Display size, character width and graphic modes are controlled by software which offers greater flexibility. The card has the advantage over some existing systems, ensuring a consistent display, by giving display generation optional priority, allowing the CPU to 'wait'. For other systems, circuit generation can result from attempted simultaneously access to screen memory by the CPU and the display, thus enabling the CPU to take control and degrading the display quality.

The card can also operate in a system with 64K RAM, display memory accessed from the CPU may be configured to 'shadow' the

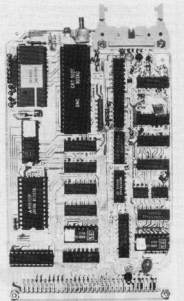

existing system memory with display memory appearing at row and column addresses to the CPU, the necessary decoding to 'linear' addressing is then transparently handled by the card.

There are three graphic modes available, one giving a bit mapped display, each memory bit corresponding to a single dot on the screen; the second divides character cell into 8 blocks, using one bit of the data word to control each block; the final mode controls predetermined graphic shapes intended for line drawings, using 3 bits in each word.

Electronic Hobbies Ltd.,  
17 Roxwell Road,  
Chelmsford,  
Essex CM1 2LY.  
Telephone: 0245.62149

(2474 M)

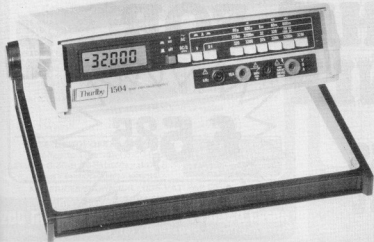

## sc/mputer (1)

build your own  
microprocessor system



the practical introduction  
to a powerful system

ELEKTOR  
BOOK  
75

A selection of some  
of the most interesting  
projects in volume 1  
of ELEKTOR magazine

the practical introduction  
to a powerful system



the practical introduction  
to a powerful system

## sc/mputer (2)

build your own  
microcomputer system

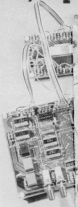

formant  
music synthesiser

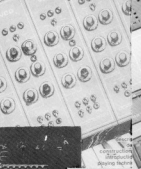

**JUNIOR COMPUTER BOOK 1** — for anyone wishing to become familiar with (micro)computers, this book gives the opportunity to build and program a personal computer at a very reasonable cost.  
Price — UK ..... **£5.00** Overseas ..... **£5.25**

**JUNIOR COMPUTER BOOK 2** — follows in a logical continuation of Book 1, and contains a detailed appraisal of the software. Three major programming tools, the monitor, an assembler and an editor, are discussed together with practical proposals for input and peripherals.  
Price — UK ..... **£5.25** Overseas ..... **£5.50**

**JUNIOR COMPUTER BOOK 3** — the next, transforming the basic, single-board Junior Computer into a complete personal computer system.  
Price — UK ..... **£5.25** Overseas ..... **£5.50**

**BOOK 4** ..... **£5.25/£5.50**

**300 CIRCUITS** for the home constructor — 300 projects ranging from the basic to the very sophisticated.  
Price — UK ..... **£4.25** Overseas ..... **£4.50**

**DIGIBOOK** — provides a simple step-by-step introduction to the basic theory and application of digital electronics and gives clear explanations of the fundamentals of digital circuitry, backed up by experiments designed to reinforce this newly acquired knowledge. Supplied with an experimenter's PCB.  
Price — UK ..... **£5.50** Overseas ..... **£5.75**

**FORMANT** — complete constructional details of the Elektor Formant Synthesiser — comes with a FREE cassette of sounds that the Formant is capable of producing together with advice on how to achieve them.  
Price — UK ..... **£5.25** Overseas ..... **£5.50**

**SC/MPUTER (1)** — describes how to build and operate your own microprocessor system — the first book of a series — further books will show how the system may be extended to meet various requirements.  
Price — UK ..... **£4.45** Overseas ..... **£4.70**

**SC/MPUTER (2)** — the second book in series. An updated version of the monitor program (Elbug II) is introduced together with a number of expansion possibilities. By adding the Elektor terminal to the system described in Book 1 the microcomputer becomes even more versatile.  
Price — UK ..... **£4.75** Overseas ..... **£5.00**

**BOOK 75** — a selection of some of the most interesting and popular construction projects that were originally published in Elektor issues 1 to 8.  
Price — UK ..... **£4.25** Overseas ..... **£4.50**

**TV GAMES COMPUTER** this book, provides a different — and, in many ways, easier — approach to microprocessors. The TV games computer is dedicated to one specific task, as the name suggests. This provides an almost unique opportunity to have fun while learning!  
Price — UK ..... **£5.50** Overseas ..... **£5.75**

When ordering please use the Elektor Reader's Order Card in this issue (the above prices include p. & p.)

## digibook

a practical introduction  
to digital electronics



300  
circuits



Elektor Publishers Ltd

# ELEKTOR BOOK SERVICE

# Make it with MAPLIN

## KEYBOARD KIT WITH ELECTRONICS FOR ZX81

- \* A full size, full travel 43-key keyboard that's simple to add to your ZX81 (no soldering in ZX81).
  - \* Complete with the electronics to make "Shift Lock", "Function" and "Graphics 2" single key selections making entry far easier.
  - \* Powered from ZX81's own standard power supply - with special adaptor supplied.
  - \* Two-colour print for key caps.
  - \* Amazing low price.
- Full details in our projects book. Price 60p. Order As XA03D.  
Complete kit for only £19.95 incl. VAT and carriage. Order As LW72P.

## 25W STEREO MOSFET AMPLIFIER

A superb new amplifier at a remarkably low price.



- \* Over 26W per channel into 8Ω at 1kHz both channels driven.
- \* Frequency response 20Hz to 40kHz ± 1dB.
- \* Low distortion, low noise and high reliability power MOSFET output stage.
- \* Extremely easy to build. Almost everything fits on main pcb, cutting interwiring to just 7 wires (plus toroidal transformer and mains lead terminations).
- \* Complete kit contains everything you need including pre-drilled and printed chassis and wooden cabinet.

Full details in our projects book. Price 60p. Order As XA03D  
Complete kit for only £49.95 incl. VAT and carriage. Order As LW1N

## MATINÉE ORGAN

Easy to build, superb specification. Comparable with organs selling for up to £1,000. Full construction details in our book. Price £2.50. Order As XH56K.  
Complete kits available:  
Electronics - £299.95  
Cabinet - £99.50 (carriage extra).  
Demo cassette price £1.99. Order As XX43W.



## HOME SECURITY SYSTEM



Six independent channels - 2 or 4 wire operation. External horn. High degree of protection and long term reliability. Full details in our projects book. Price 60p. Order As XA02C.

## MAPLIN'S FANTASTIC PROJECTS

Full details in our project books only 60p each.

- In Book 1 (XA01B)** 120W rms MOSFET Combo Amplifier - Universal Timer with 18 program times and 4 outputs - Temperature Gauge - Six Vero Projects
- In Book 2 (XA02C)** Home Security System - Train Controller for 14 trains on one circuit - Stopwatch with multiple modes - Miles-per-Gallon Meter
- In Book 3 (XA03D)** ZX81 Keyboard with electronics - Stereo 25W MOSFET Amplifier - Doppler Radar Intruder Detector - Remote Control for Train Controller
- In Book 4 (XA04E)** Telephone Exchange expandable up to 32 extensions - Ultrasonic Intruder Detector - Frequency Counter 100Hz to 500MHz - Remote Control for 25W Stereo Amplifier

\*Projects for book 4 were in an advanced state at the time of writing, but contents may change prior to publication (see 14th Aug 1982).

## MORE GREAT KITS FROM MAPLIN

Matinée Organ (see box above)

- Spectrum Synthesiser. Full details in book XH56L. Price £1.00
- 3800 Synthesiser } Full details in book XF11M. Price £2.00
- 5600S Synthesiser }
- 150W Power Amp Kit LW32K. Price £17.95\*
- 75W MOSFET Power Amp Kit LW51F. Price £11.49\*
- 50W Power Amp Kit LW35Q. Price £14.95\*
- 15W Power Amp Kit YQ43W. Price £6.45\*
- 8W Power Amp Kit LW36P. Price £4.45\*

\*Construction details with kit. (Power supply not included - details with kit).

**MAPLIN** ELECTRONIC SUPPLIES LTD.

All mail to:

P.O. Box 3, Rayleigh, Essex SS6 8LR  
Tel: Sales (0702) 552911 General (0702) 554155

Shops at:  
159 King St., Hammersmith, London W6. Tel: 01-748 0926  
284 London Rd., Westcliff-on-Sea, Essex. Tel: (0702) 554000  
Lynton Square, Perry Barr, Birmingham. Tel: (021) 356 7292  
Note: Shops closed Mondays

## Maplin launches MAPCARD

A new way of buying from Maplin!

Now Maplin have their own credit card. You could have one too!



### APPLY NOW!

Write to our Rayleigh address for details or pick up a leaflet in our shops.

## NEW SHOP IN BIRMINGHAM

Visit our brand new shop in Birmingham for our complete range of electronic components and computers.

Come and see us at Lynton Square, Perry Barr, Birmingham (just off the junction of the Outer Ring Road A4040 and Birchfield Road A34). Tel: 021-356-7292. Excellent free parking.

Opening Tuesday 24th August, 1982



Don't miss out - get a copy of our catalogue now! Over 140,000 copies sold already!

On sale now in all branches of WHSMITH price £1.

320 big pages packed with data and pictures of over 5,500 items.



### Post this coupon now!

Please send me a copy of your 320 page catalogue. I enclose £1.25 (inc. 25p p&p). If I am not completely satisfied I may return the catalogue to you and have my money refunded.  
If you live outside the U.K. send £1.68 or 12 International Reply Coupons.

Name

Address

E1082